

A NEW HYBRID APPROACH TO THE IMPACT OF RENEWABLE ENERGY CONSUMPTION ON ECONOMIC GROWTH: SECTORAL DIFFERENCES IN EUROPEAN UNION COUNTRIES

Anca MEHEDINTU , Georgeta SOAVA 

Department of Statistics and Economic Informatics, Faculty of Economics and Business Administration, University of Craiova, Craiova, Romania

Article History:

- received 3 September 2023
- accepted 14 May 2024

Abstract. The current energy crisis has shown all states that energy from renewable sources can be a determining factor in the states' sustainable development. Several papers have studied the relationship between renewable energy consumption and economic development, finding various situations, but there is no consensus. Thus, this study aims to first investigate the causal relationship between economic growth and total and sectoral renewable energy consumption (European Union and each Member State, for 2004–2020) by testing various linear and non-linear regressions to choose the fit model. Second, the investigation extends to analysing the impact of renewable energy consumption by sector on economic development. A hybrid approach is used, namely structural equation modelling and artificial neural networks. The study findings indicate the effect and the meaning (directly or inversely) exerted by the three sectoral components on economic growth, with different intensities from one country to another. There is a significant influence on the consumption of renewable energy in the heating and cooling sectors and transport on gross domestic product at the European Union level and for most member states. Based on the obtained results, a series of theoretical, practical, and political implications are provided.

Keywords: economic growth, granger causality, neural network artificial, renewable energy consumption, sector data, structural equation modelling.

JEL Classification: C31, C45, O47.

Corresponding author. E-mail: anca.mehedintu@edu.ucv.ro

1. Introduction

Energy consumption is the basis of the economic development of any country. In the long term, economic growth is the main factor leading to increased energy consumption (Mohsin et al., 2022). A sustainable economic development requires states to reduce energy consumption from conventional sources and replace it with energy from renewable sources, political decision-makers showing a real interest in implementing measures to improve the quality of the environment, which implies a series of measures for reforming energy policy and the transition from the use of fossil fuels to the use of renewable energy resources. In this sense, it has been noticed more and more, in recent years, that the use of energy from renewable sources is becoming an essential factor in satisfying the global energy demand, but is conditioned by the degree of economic development of a

country, the structure energy consumption, energy resources, and energy policy efficiency (Odugbesan & Rjoub, 2020).

Initially, by 2020, the European Union (EU) Renewable Energy Directive (Directive 2009/28/EC) provided for a 20% share of renewable energy consumption in final energy consumption for each EU country. According to Eurostat Database (2022a), at the EU level, the target has been reached, but for their countries, the situation is different, some exceeded the target set others are still far away (Anton & Afloarei Nucu, 2020). Thus, the target set for 2020 is exceeded at EU27 level (22.1%), and in 15 other countries (Sweden – 60.1%, Finland – 43.8%, Latvia – 42.1%, Austria – 36.5%, Portugal – 34%, Denmark – 31.6%, Croatia – 31%, Estonia – 30.1%, Lithuania – 26.8%, Slovenia – 25%, Romania – 24.5%, Bulgaria – 23.3%, Greece – 21.7%, Spain – 21.2%, Italy – 20.4%). While two countries are closer to reaching the objective (Germany – 19.3%, France – 19.1%), 10 countries failed to meet the target (Slovakia and Czechia – 17.3%, Cyprus – 16.9%, Ireland – 16.2%, Poland – 16.1%, Netherlands – 14%, Hungary – 13.9%, Belgium – 13%, Luxembourg – 11.7%, Malta – 10.7%). Under the Revision of the Renewable Energy Directive (European Commission, 2021), for 2030, EU countries must increase the amount of renewable energy use by 38%–40%.

The share of renewable energy consumption in total energy consumption by sectors of activity is very different in the EU. Although, in some sectors, renewable energy consumption has increased significantly in recent years, and increases are still expected (in the electricity and heating and cooling sectors) (IEA, 2022), there are still problems in meeting the targets set by the EU in the transport sector. The European Union's new renewable energy specifications (European Commission, 2021) envisage an increase in it for the heating and cooling sector, with an annual increase of 1.1 percentage points until 2030 and an increase in the transport sector from 14% in 2020 to 26% in 2030.

In this paper, we took into account that the economic development of any country, regardless of size, must be based on an efficient energy policy. In the long run, it is considered that economic growth (measured by gross domestic product–GDP) is the main factor leading to increasing in energy consumption (Mohsin et al., 2022). The Russian-Ukrainian conflict that broke out over the effects of the COVID-19 pandemic produced a global energy crisis. This made all EU countries aware of the need to ensure energy security. Thus, a sustainable energy policy based predominantly on renewable energy must be applied (Odugbesan & Rjoub, 2020; Inês et al., 2020).

Research on this relationship has become even more pronounced due to global energy crises that have demonstrated to all states that energy is the fundamental element of sustainable development (Pan et al., 2023). However, despite more studies, there is still no consensus on the theories related to the relationship between renewable energy consumption (RE_FEC) and GDP (Chen et al., 2023).

This study investigates the link between RE_FEC and GDP for EU and member countries in 2004–2020. This is a topic of both scientific and political interest to take efficient environmental and energy policy measures. In this sense, the research comprises two parts. In the first part, an economic analysis of the evolution of the indicators during the analyzed period is carried out and the existence of causality between RE_FEC and GDP by estimating several linear and non-linear regression models for the EU and each member country by testing Granger causality and Johansen cointegration. In the second part, using the structural equation model (SEM) and neural networks (ANN), the share of renewable energy consumption impacts in the global energy consumption by sectors on economic growth for the EU and each EU country is studied. The novelty of the research consists of the

research methodology chosen. The integrated SEM-ANN model for measuring renewable energy consumption impact by sectors on GDP provides a new impact and a possible new research paradigm because it uses both linear and nonlinear relationships. Some studies analyze the correlation between energy consumption and GDP by different econometric models (cointegration tests and the model of vector errors, generalized method of moments, or self-regressive models distributed lag). Very few researches have used only artificial neural networks to investigate this link.

The methodology used in this research consists of testing the causality between RE_FEC and GDP and identifying the share of energy consumption from renewable sources impacts the final energy consumption by sectors on GDP through the use of SEM and ANN. SEM is used to determine each sector's (electricity, heating and cooling, transport) consumption impact on GDP and to what extent it influences it. Then, to achieve a ranking of the influence of the predictors on the GDP determined by SEM, ANN models were used. The study results demonstrate that the integrated SEM-ANN model use has two significant contributions. The first contribution consists of the validation by ANN of the correlations established by SEM. The second contribution is determined by the fact that the integrated model approach considers both linear and complex non-linear relationships between variables, identifying with better accuracy the relative influence of each predictor.

The results indicate that RE_FEC has a positive impact on GDP in all countries and the EU, but the effect of renewable energy consumption by sectors on GDP is different between countries.

It can be concluded that both at the level of each EU member state and at the level of the entire EU, there is a need to adopt and apply sustainable energy policies to ensure energy security and promote the use of renewable energy.

The research has five sections. The first two sections, introduction and literature review, present the general framework of the research. The study data and methodology are presented in the third section. Section four comprises the study results and related discussions. The last section includes a set of conclusions with several theoretical and practical implications. At the same time, the limitations of the current research are specified, and future lines of research are drawn.

2. Literature review

Analyzing the studies that investigated the link between the RE_FEC and GDP, the results fall according to the country, the areas, the development degree, the time, and the models (El-Karimi, 2021; Krkošková, 2021), in four hypothetical relationships: (1) the growth hypothesis – the energy consumption rate directly or indirectly influences the level of GDP (Xie et al., 2023); (2) interdependence link between the two variables – the feedback hypothesis (Mughal et al., 2022; Jia et al., 2023); (3) the conservation hypothesis (opposed to the growth hypothesis), respectively, GDP influences the energy consumption rate (Radmehr et al., 2021); (4) no link between the two indicators is identified – the neutrality hypothesis (El-Karimi, 2021; Ivanovski et al., 2021; Pejovic et al., 2021).

Some studies have shown that increasing RE_FEC can negatively affect GDP, respectively, and RE_FEC can lead to slow down GDP, depending on the countries studied (for low-income countries (Nguyen & Kakinaka, 2019)) and depending on the period studied (short term (Alam & Murad, 2020)). Comparative studies have provided different results. Thus, it is found that in some countries with middle and high incomes a low level of RE_FEC can negatively affect

GDP but it can be significantly increasing when developing countries exceed a certain critical threshold of renewable energy consumed (Chen et al., 2020).

At the EU level, the results were found to differ in developed countries compared to emerging ones. Thus, at the level of developed states, RE_FEC has a negative impact on GDP, and the consumption of energy from fossil fuels has a positive impact. As far as emerging countries are concerned, the results obtained are the opposite, i.e. these countries tend to move faster to consumption from renewable sources, which are a stimulus for GDP (Šikic, 2020).

For developing states in Asia, Latin America, and the Caribbean, only for certain countries was a significant long-term relationship between RE_FEC and GDP found (Ahmed & Shimada, 2019). Some studies have found that both, in the short and long term, RE_FEC has a positive impact on GDP (Khribich et al., 2021).

Analyzing the trends and variations of energy consumption in different economic sectors of the EU countries (Komarnicka & Murawska, 2021), it was found that GDP and the energy industry are interdependent. Energy is needed for the function of all economic sectors, but the share of consumption is different, the transport sector has the highest energy consumption, followed by the industrial and household sectors.

In 2019 households sector accounted for 26.3% of final energy consumption in the EU (European Environment Agency, 2022). The main energy use by EU households in 2019 was for home heating (64% of final energy consumption in the residential sector), with renewable sources accounting for more than a quarter (28%) of EU household heating consumption (European Commission, 2022). According to Eurostat, in 2019, approximately 75% of heating and cooling (H&C) came from conventional fuels, and only 22% was provided by renewable sources (Eurostat, 2022b). To meet the EU's climate change targets, the H&C sector needs to drastically reduce its use of fossil fuels and increase its RE_FEC. To improve the performance and energy efficiency of the office and living spaces, it is necessary to make intelligent control of the operation of electronic equipment (Kim et al., 2020; Guliyev & Tatoğlu, 2023).

To reduce carbon emissions, countries must promote increasing RE_FEC in the transport (Li et al., 2021). Thus, the intelligent integration of electric transport in the energy system will create a more environmentally robust future (Hinov et al., 2021).

The evolution and efficiency of the energy sector support not only GDP but also the economic competitiveness of all countries (Simionescu et al., 2020), so is a need to increase RE_FEC in transport, industry, and other sectors.

To achieve sustainable development at the EU level, the effect of the development of the renewable energy sector on the relationship between electricity consumption and GDP has been assessed (Abbasi et al., 2021), finding that the greater the share of the renewable energy sector in the economy, thus the interdependence between GDP and RE_FEC is stronger (Jia et al., 2023).

In the case of the Baltic States, it has been found that GDP has led to an increase in the consumption of renewable electricity but not vice versa (Furuoka, 2017). Some studies show that electricity does not affect GDP, while others support the growth hypothesis of RE_FEC in industrial and residential energy consumption (Burke et al., 2018).

3. Methodology: data and models

The research analyzed the following macroeconomic indicators: GDP measured in millions of euros; RE_FEC measured in thousand tons of oil equivalent (TOE); share renewable energy

consumption in final energy consumption by sectors: electricity (REE), heating and cooling (REHC), and transport (RET) expressed in percent. The indicator values are extracted from the Eurostat Database (2022a) for 2004–2020.

The study comprises two parts.

First, an economic analysis of the indicators evolution is carried out and it analyzes the Granger causality between GDP and RE_FEC, and GDP with the share of RE_FEC in the total energy consumption by sectors. The endogenous and exogenous variables are established, and the specific regression functions (linear or non-linear) are identified, tested and estimated using the IBM SPSS to identify best fit regression curve. Is tested the variables' stationarity (Augmented Dickey-Fuller-test), and the degree of their cointegration is identified. If the data are integrated, is verified the cointegration relationship (Johansen-procedure). Subsequently, the causal relationships between the variables and the direction of these are verified using error correction models and Granger causality tests. It is checks model validity (White-test) and whether the errors are heteroscedastic/homoscedastic.

In second part, the impact of the share of RE_FEC in the final energy consumption by sector (electricity, H&C, transport) on GDP was investigated, both of each country and the EU.

Identifying the relationship between GDP and REE, REHC, and RET, for the EU and each EU country first involved estimating the parameters of the multifactorial linear equation. Then, through SEM and ANN, the effect of REE, REHC, and RET on GDP and its ranking is determined. SEM modelling is performed using Eq. (1):

$$\eta = \beta\eta + \Gamma\xi + \zeta, \quad (1)$$

where: β – the path coefficient matrix between the exogenous latent variables η ; Γ – the path coefficient matrix of the endogenous latent variables ξ ; ζ – the residual term.

The structural model is tested and validated using the SPSS-Amos.

After building SEM models, it used ANN because it provides predictions with better accuracy than SEM (Albahri et al., 2022). The chosen ANN model is multilayer perceptron (MLP) because it is reliable for the studied indicators. The ANN is built in three layers (input, hidden, and output). The MLP activation functions are used. These indicate the capacity and performance of ANN (hidden layer) and determine the validity of the chosen regression model (output layer). The connection magnitude and the significance of the relationship between the nodes (direct or indirect) is given by the Synaptic Weight. The best fit to the analyzed data is given by the Bias Parameter. In the construction of ANN, the hidden neurons (nodes) were considered to be automatically generated and are used as activation functions for the hidden Hyperbolic Tangent layer and the Sigmoid output layer. ANN prediction accuracy is achieved by first dividing the data sets into training and test data. Then, ANN will be run multiple times as necessary to obtain the best solution (Ooi & Tan, 2016). The model's prediction accuracy assessment is done by root mean square error (RMSE) (Eq. (2)) (Gong et al., 2023):

$$RMSE = \sqrt{\frac{1}{N} \times SSE}, \quad (2)$$

where: SSE – sum of squares error; N – the number of values.

4. Empirical results and discussions

4.1. Analysis of the relationships between macroeconomic indicators

4.1.1. Economic analysis of indicators

The socio-economic effects of increasing the share of renewable energy can materialize in macroeconomic effects on GDP, welfare, employment, and trade balance (including trade in energy products and equipment).

The RE_FEC impact magnitude on GDP varies from country to country depending on the country's economic structure, the costs of alternative energy sources, and the necessary equipment and services that are imported or provided locally. Thus, increasing the share of renewable sources affects a country's GDP through investment, trade, and electricity prices.

The most important positive effects of RE_FEC on GDP are driven by increased investment in renewable energy use (without reducing investment in other economic sectors), which triggers ripple effects throughout the economy and brings substantial benefits, energy security, and environmental protection.

The importance of the investment effect is felt not only in global GDP changes but also at the sectoral level. Directed investment in any economic sector can boost GDP, and the energy sector attracts the investment majority.

The overall economic growth due to renewable energy use causes most economic sectors to increase their output. Increased activity in these sectors has effects on the rest of the economy.

Within the H&C segment, energy intensity will decrease as new, energy-efficient technologies are adopted. The transport sector will be most efficient by using energy from renewable sources. The shift to electric vehicles, combined with improvements in internal combustion engine vehicles, means that the total energy requirement for road transport will increase very little, even as the total number of cars increases substantially.

Electricity prices change according to the technologies and costs of the energy mix. As the share of renewable energy increases, with the lower costs of producing energy from renewable sources compared to conventional sources, it will lead to lower electricity prices. Thus, lower electricity prices can lower inflation, increase real household incomes and consumption, and stimulate economic activity in electricity-intensive sectors.

The GDP analysis in 2004–2020 shows an increase in most countries (except EL) with a preponderance at the level of emerging countries. In 2020, due to the COVID-19 pandemic, GDP decreased in most countries (except Denmark, Ireland, Lithuania, and Luxembourg). At the EU level, the decrease in 2020 was 4.4%, but during 2004–2020, the increase was over 46%, with an average annual rate of 2.4% (Table 1, Figure 1).

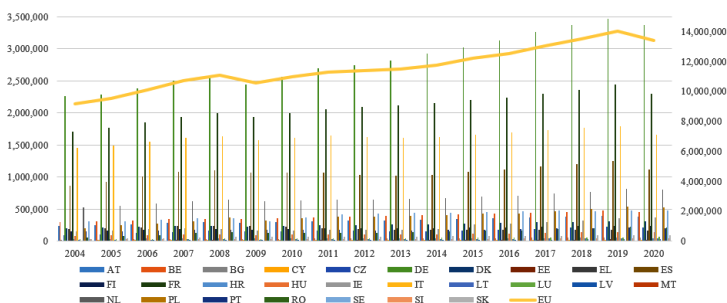



















































































































































Figure 1. GDP evolution

Table 1. Indicators evolution and average annual growth rate for 2004–2020

Co.	GDP		RE_FEC		REE(%)		REHC(%)		RET(%)	
		Trend/AGR		Trend/AGR		Trend/AGR		Trend/AGR		Trend/AGR
AT		2.9		3.5		1.5		3.6		6.1
BE		2.8		9.3		18		7.1		28
BG		7.1		5.1		6.9		6.6		52
CY		2.9		10		62		9.5		–
CZ		5.4		5.2		9.5		5.6		36
DE		2.6		4.6		10		4.8		12
DK		2.8		3.9		6.6		5.9		28
EE		6.9		0.4		35		3.8		62
EL		–0.8		3.2		10		5.8		92
ES		1.8		3.9		5.4		4.3		38
FI		2.6		2.2		2.5		2.4		76
FR		1.9		2.8		3.8		4.1		78
HR		2.7		56		2.8		1.5		22
HU		3.3		7.8		13		7.8		22
IE		5.9		7.9		12		5.3		56
IT		0.9		10		5.7		9.1		19
LT		6.8		0.8		11		3.3		24
LU		5.3		17		10		14		81
LV		6.6		0.4		1.0		2.1		12
MT		6.4		48		16		29		–
NL		2.7		8.7		12		8.8		33
PL		6.3		6.1		14		5.4		13
PT		1.8		1.2		4.9		1.7		49
RO		8.9		1.6		2.8		2.6		20
SE		2.9		4.8		2.4		2.4		10
SI		3.4		0.9		1.2		2.4		22
SK		6.5		10		2.6		10		14
EU		2.4		3.9		5.6		4.4		14

Note: Co. – Country; AT – Austria; BE – Belgium; BG – Bulgaria; CY – Cyprus; CZ – Czech Republic; DE – Germany; DK – Denmark; EE – Estonia; EL – Greece; ES – Spain; FI – Finland; FR – France; HR – Croatia; HU – Hungary; IE – Ireland; IT – Italy; LT – Lithuania; LU – Luxembourg; LV – Latvia; MT – Malta; NL – Netherlands; PL – Poland; PT – Portugal; RO – Romania; SE – Sweden; SI – Slovenia; SK – Slovak Republic; EU – European Union.

RE_FEC increased significantly compared to 2004 in all states, leading to an increase in the EU as well, with an AGR of 4%. Among the EU states that consume large amounts of energy, Italy and Germany, although they have marked significant increases in RE_FEC compared to 2004, are far from achieving the EU objectives for 2020 (Table 1, Figure 2).

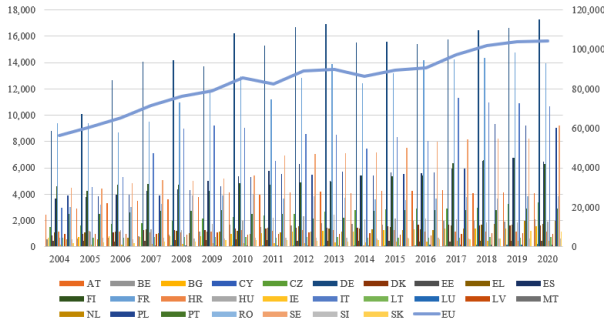

Figure 2. RE_FEC evolution

The analysis of RE_FEC share in final energy consumption by sectors in 2004–2020 shows a permanent increase in the three sectors in the EU and all countries, and the largest share goes to REE (with the highest AGR), followed by H&C and then RET. The EU has established as a general objective for 2020 that 10% of the energy consumption used in transport be from renewable sources. According to the data at the EU, the RET is 10.2%, with an AGR of 14.2%, which means that the objective has been met. All countries recorded significant increases in H&C, thus the EU as a whole recorded an AGR of 4.4% (Table 1, Figure 3).

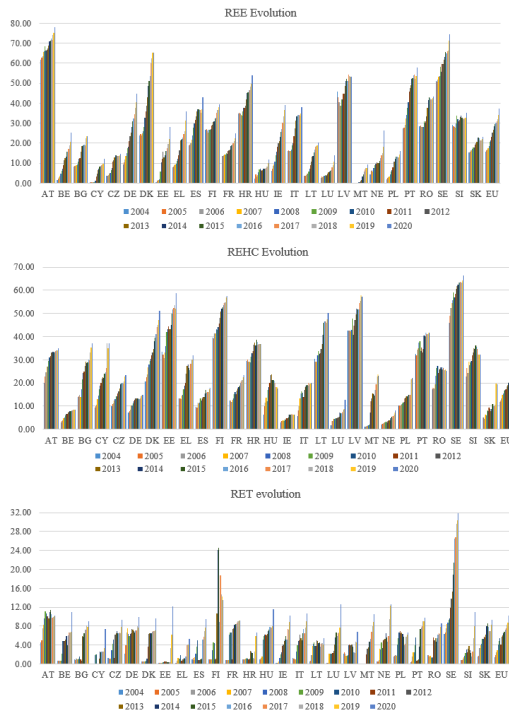

Figure 3. RE_FEC by sectors evolution

4.1.2. Analysis of the relationships between RE_FEC and GDP, and the share of renewable energy in total energy consumption by sector and GDP

The relationship identification between GDP and RE_FEC was achieved by estimating linear and non-linear regression using the endogenous variable GDP (y) and the exogenous variable RE_FEC (x).

Motivated by the fact that REE, REHC, and RET are structural elements in the RE_FEC, we set out to establish the relationship between these indicators and GDP through statistical methods. Thus, the multifactorial regression models were tested considering the endogenous variable GDP and the exogenous variables REE, REHC, and RET.

By logarithmic, the GDP and RE_FEC variables are interpreted as elasticity coefficients.

Estimating the regression parameters of the relationship LGDP with LRE_FEC for EU and each country shows that, in most cases, the optimal regression model is the linear one (Eq. (3)) (Appendix, Table A1).

For the relationship analysis between LGDP and REE, REHC, and RET, shows the optimal model is the multifactorial linear regression (Eq. (4)) (Appendix, Table A2):

$$LGDP_{it} = \alpha_i + \beta_i LRE_FEC_{it} + u_{it}; \quad (3)$$

$$LGDP_{it} = \alpha_i + \beta_{1i} REE_{it} + \beta_{2i} REHC_{it} + \beta_{3i} RET_{it} + u_{it}, \quad (4)$$

where $i = 1 \dots N$, is the country index, $t = 1 \dots T$, refers to the time period, and u_{it} ($i = 1 \dots N$) are the error terms.

Linear and non-linear regression coefficients according to the tests are not significant for four countries (Estonia, Croatia, Lithuania, Latvia), so the regression models are not significant in identifying the RE_FEC impact on GDP.

The relationship analysis between GDP and RE_FEC for Romania and Slovenia shows that the quadratic model (Eq. (5)) is significant:

$$LGDP_{it} = \beta_0 + \beta_1 LRE_FEC_{it} + \beta_2 LRE_FEC_{it}^2 + \beta_3 Z_{it} + u_{it}, \quad (5)$$

where Z is the explanatory variable, while u_{it} is the error term, i symbolizes countries and t is time.

The relationship between LGDP and LRE_FEC follows an inverted U-shaped curve since $\beta_2 < 0$.

For 4 states (Bulgaria, Greece, Malta, Slovakia), the optimal regression model is the exponential (non-linear):

$$LGDP_{it} = \alpha_i e^{\beta_i LRE_FEC_{it}}. \quad (6)$$

Thus, to obtain the regression curve, it is necessary to linearize these curves by transforming the exponential equation into a linear one:

$$\ln LGDP_{it} = \ln \alpha_i + \beta_i LRE_FEC_{it}. \quad (7)$$

For the error normalization, it was used the Jarque-Bera-test, and it determined that the variables haven't a normal distribution. Following the analysis of the estimated regression coefficients values $\hat{\beta}_i$ for the variable LRE_FEC_{it} , we observe that all coefficients $\hat{\beta}_i$ are positive (except EL), indicating a favorable impact of RE_FEC on GDP.

The analysis of the estimated regression coefficients values $\hat{\beta}_i$ for the REE_i variable for 14 countries and the EU are positive, which indicates a favorable impact of REE on GDP. The impact is unfavorable for 13 countries. The estimated regression coefficients values $\hat{\beta}$ for the variable $REHC_i$ show a favorable impact of REHC on GDP for most states and the EU (except for 4 states: EL, HU, IE, and SK). The impact of the RET_i variable on LGDP is generally favorable (for 17 countries and the EU) (Appendix, Table A2).

The ADF test was used to test the stationarity and identify the degree of the data series integration. It is found that the variables GDP and RE_FEC, being at nominal values, are non-stationary. Thus, they were transformed into stationary series, and integration was performed at the first difference, at least at the 10% level.

The data series stationarity by differencing can have the disadvantage of long-term dynamics of losing the information content of the data. This inconvenience is removed by applying the Johansen-test for cointegration analysis. Cointegration testing of variables shows that there are long-run equilibrium relationships between variables (LGDP and LRE_FEC, LGDP and REE, REHC, and RET) for the 5% significance. It follows that there is Granger causality between the variables at least in one direction.

Applying the Granger causality test, the following results are obtained:

- LRE_FEC↔LGDP is bidirectional causality for: CY, CZ, LU, NL, RO, SE;
- unidirectional causality: LRE_FEC→LGDP for EL, LT;
- unidirectional reverse causality: LRE_FEC←LGDP for BE, BG, ES, FI, FR, IT, MT, PL, PT, EU;
- there is no causality between LRE_FEC and LGDP in: AT, DE, DK, HI, IE, SI, SK;
- bidirectional causality REE↔LGDP for: ES, FI, IT, MT, PL, SE, EU;
- unidirectional causality REE→LGDP for: DE, DK, EL, PT, RO;
- unidirectional causality LGDP→REE for: AT, BG, CY, CZ, HU, IE, NL, SI, SK;
- there is no causality between REE and LGDP in: BE, FR, LU;
- bidirectional causality REHC↔LGDP for IE, SE;
- unidirectional causality REHC→LGDP for: CY, DK, EL, FI, IT, NL, PT;
- unidirectional causality LGDP→REHC for: BE, BG, FR, PL, RO, SI, SK, EU;
- there is no causality between REHC and LGDP in: AT, CZ, DE, ES, HU, LU, MT;
- bidirectional causality RET↔LGDP for: BG, DK, HU, IT;
- unidirectional causality RET→LGDP for: CY, EL, PT, RO;
- unidirectional causality LGDP→RET for: BE, CZ, DE, ES, FR, IT, MT, NL, SE, SI, SK, EU;
- there is no causality between RET and LGDP in: AT, FI, LU, PL.

It continues by testing the cointegration equation validity with the White-test and checking if have homoscedasticity or not. The results show homoscedasticity for the LGDP and LRE_FEC relationship for 17 countries and the EU (where the linear model is optimal). So, the models are valid. There is heteroscedasticity for the other six countries that assumed linearization of the models.

Using the White-test to the cointegration equation specific to the relationship of LGDP with REE, REHC, and RET demonstrates homoscedasticity for the tested countries and the EU.

After carrying out all tests, it is noted that the chosen regression models are valid for most states and the EU. Also, it can be concluded that growth in RE_FEC determines increased GDP in most states and the EU. Thus, more intensive use of renewable energy could generate a positive acceleration of the GDP, a conclusion also drawn by other authors (El-Karimi, 2021; Radmehr et al., 2021).

It is found that between the variables (LGDP and LRE_FEC, as well as between LGDP and REE, REHC, and RET), there are different types of Granger causality being a long-term equilibrium relationship between them, regarding the countries' development level and the degree implementation of RE_FEC in total energy consumption, results confirmed by other studies (Mughal et al., 2022; Ivanovski et al., 2021; Pejovic et al., 2021).

4.2. Identifying the renewable energy consumption sector with the most significant impact on GDP

Since the increase in the demand for electricity in the heating-cooling and transport sectors affects the increase in REE, multicollinearity was tested by the variant inflation factor (VIF) (Appendix, Table A2). It's found that in some countries the VIF for REE is between 5–10 (moderate multicollinearity accepted). Therefore, were analyzed the direct and indirect (mediation) effects through which REHC and RET mediate the impact of REE on LGDP. To identify the links between variables and their meaning was used SEM, and validated by ANN. SEM defines endogenous variables (LGDP, REHC, RET) and exogenous variables (REE). The model includes three residual error terms (e1–e3) influencing the endogenous variables.

Based on the multifactorial linear regression tested in paragraph 4.1 to identify the link between the endogenous variable LGDP and the exogenous variables REE, REHC, and RET, it was analyzed using the structural equation model. The SEM is then validated using ANN.

The SEM defines an endogenous variable (LGDP) and three exogenous variables (REE, REHC, RET). In addition, the model includes a residual error term (e1) that influences the endogenous variable.

Similar to the realization of SEM at the EU level, was carried out for all states, and the findings are in Table 2. The standardized values from Table 2 show the direct, indirect and total effects of REE, REHC, RET on LGDP. SEM fitting effect shows that is the interaction between variables. The models were continuously optimized by testing this effect until the models with the best-fitting effects were found.

Figure 4 shows the structural links between variables for the data from the EU level.

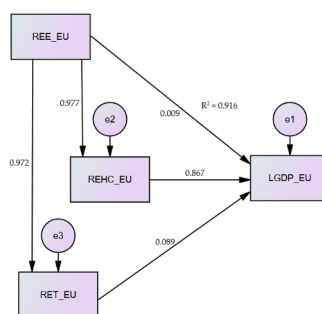

Figure 4. The diagram of the relationships in SEM for EU

The SEM fitting indices constructed at the level of each country and the EU recorded the values: Chi-Square has values below 0.05 which means the results are statistically significant (Ullman, 2001), Root Mean Square Error of Approximation (RMSEA) between 0.06–0.07, Normed-fit Index (NFI) and Comparative Fit Index (CFI) above 0.95 (Hu & Bentler, 1999), Goodness-of-Fit (GFI) above 0.95 (Hair et al., 2010). These values prove a good significance

for the SEMs used. At the EU level, SEM from Figure 4 shows that the value of R^2 is 0.916 (91.6% of the LGDP variation can be explained by REE, REHC, RET), which proves that the predictive power for LGDP is very good (Hair et al., 2013). Similarly, for each country, it is noted the predictive power of this construct is strong because R^2 values are between 0.751 and 0.929.

Table 2. The impact of REE, REHC, RET on LGDP of each country and the EU level

Co.	Effects	Significance Impact RE_FEC by sector		
	Direct	Direct		Reverse
	Indirect			
	Total			
AT	REHC(0.644 ^{1,***})	REE(0.545 ^{1,***})		RET(-0.228 ^{2,*})
	REE(0.366 ^{1,***})			
	REE(0.917 ^{1,***})	REHC(0.644 ^{1,***})		RET(-0.228 ^{2,*})
BE	REE(0.823 ^{1,***})	REHC(0.481 ^{1,***})		RET(-0.316 ^{2,*})
	REE(0.136 ^{3,***})			
	REE(0.959 ^{1,***})	REHC(0.481 ^{1,***})		RET(-0.316 ^{2,*})
BG	REHC(0.930 ^{1,**})	RET(0.071 ^{3,*})		REE(-0.263 ^{2,*})
	REE(0.968 ^{1,*})			
	REHC(0.930 ^{1,**})	REE(0.705 ^{1,*})	RET(0.071 ^{3,*})	
CY	REHC(0.995 ^{1,***})			REE(-0.781 ^{1,***}) RET(-0.037 ^{3,*})
	REE(0.940 ^{1,***})			
	REHC(0.995 ^{1,***})	REE(0.159 ^{2,***})		RET(-0.037 ^{3,*})
CZ	REHC(0.994 ^{1,***})			REE(-0.388 ^{1,*}) RET(-0.135 ^{3,*})
	REE(0.804 ^{1,*})			
	REHC(0.994 ^{1,***})	REE(0.416 ^{1,*})		RET(-0.135 ^{3,*})
DE	REE(0.910 ^{1,***})	REHC(0.088 ^{3,*})		RET(-0.007 ^{3,*})
	REE(0.073 ^{3,***})			
	REE(0.983 ^{1,***})	REHC(0.088 ^{3,*})		RET(-0.007 ^{3,*})
DK	REHC(0.985 ^{1,***})	REE(0.058 ^{3,*})		RET(-0.045 ^{3,*})
	REE(0.807 ^{1,*})			
	REHC(0.985 ^{1,***})	REE(0.865 ^{1,*})		RET(-0.045 ^{3,*})
EL	RET(0.618 ^{1,**})			REE(-0.966 ^{1,**}) REHC(-0.156 ^{2,*})
	REE(0.165 ^{2,**})			
	RET(0.618 ^{1,**})			REE(-0.801 ^{1,**}) REHC(-0.156 ^{2,*})
ES	REHC(0.948 ^{1,***})	RET(0.071 ^{3,*})		REE(-0.726 ^{1,*})
	REE(0.920 ^{1,*})			
	REHC(0.948 ^{1,***})	REE(0.194 ^{2,*})	RET(0.071 ^{3,*})	

Continued Table 2

Co.	Effects	Significance Impact RE_FEC by sector		
	Direct	Direct		Reverse
	Indirect			
	Total			
FI	REHC(0.900 ^{1,***})			RET(-0.180 ^{2,*}) REE(-0.106 ^{3,*})
	REE(0.875 ^{1,*})			
	REHC(0.900 ^{1,***})	REE(0.769 ^{1,*})		RET(-0.180 ^{2,*})
FR	REHC(0.737 ^{1,*})	RET(0.163 ^{2,*})	REE(0.060 ^{3,*})	
	REE(0.849 ^{1,*})			
	REE(0.909 ^{1,*})	REHC(0.737 ^{1,*})	RET(0.163 ^{2,*})	
HU	REE(0.786 ^{1,*})	RET(0.165 ^{2,*})		REHC(-0.150 ^{2,*})
	REE(0.061 ^{3,*})			
	REE(0.847 ^{1,*})	RET(0.165 ^{2,*})		REHC(-0.150 ^{2,*})
IE	REE(0.945 ^{1,***})			RET(-0.927 ^{1,**}) REHC(-0.357 ^{1,*})
				REE(-0.051 ^{3,***})
	REE(0.894 ^{1,***})			RET(-0.927 ^{1,**}) REHC(-0.357 ^{1,*})
IT	REHC(0.747 ^{1,***})	RET(0.242 ^{2,*})		REE(-0.115 ^{3,*})
	REE(0.853 ^{1,*})			
	REHC(0.747 ^{1,***})	REE(0.738 ^{1,*})	RET(0.242 ^{2,*})	
LU	RET(0.805 ^{1,*})	REHC(0.431 ^{1,*})		REE(-0.138 ^{3,*})
	REE(0.949 ^{1,*})			
	REE(0.811 ^{1,*})	RET(0.805 ^{1,*})	REHC(0.431 ^{1,*})	
MT	REE(0.852 ^{1,***})	REHC(0.777 ^{1,***})		RET(-0.612 ^{1,*})
	REE(0.069 ^{3,***})			
	REE(0.921 ^{1,***})	REHC(0.777 ^{1,***})		RET(-0.612 ^{1,*})
NL	REHC(0.759 ^{1,***})	RET(0.408 ^{1,*})		REE(-0.211 ^{2,*})
	REE(0.989 ^{1,*})			
	REE(0.778 ^{1,*})	REHC(0.759 ^{1,***})	RET(0.408 ^{1,*})	
PL	REE(0.589 ^{1,***})	REHC(0.227 ^{2,*})	RET(0.192 ^{2,*})	
	REE(0.325 ^{2,***})			
	REE(0.914 ^{1,***})	REHC(0.227 ^{2,*})	RET(0.192 ^{2,*})	
PT	RET(0.667 ^{1,***})	REE(0.161 ^{2,*})	REHC(0.118 ^{3,*})	
	REE(0.593 ^{1,*})			
	REE(0.754 ^{1,*})	RET(0.667 ^{1,***})	REHC(0.118 ^{3,*})	
RO	REHC(0.439 ^{1,***})	RET(0.401 ^{1,*})	REE (0.137 ^{3,*})	
	REE(0.645 ^{1,*})			
	REE(0.782 ^{1,*})	REHC(0.439 ^{1,***})	RET(0.401 ^{1,*})	

End of Table 2

Co.	Effects	Significance Impact RE_FEC by sector			
	Direct	Direct			Reverse
	Indirect				
	Total				
SE	RET(0.642 ^{1,**})	REHC(0.619 ^{1,***})			REE(-0.290 ^{2,*})
	REE(0.967 ^{1,*})				
	REE(0.677 ^{1,*})	RET(0.642 ^{1,**})	REHC(0.619 ^{1,***})		
SI	RET(0.642 ^{1,***})	REHC(0.527 ^{1,***})			REE(-0.096 ^{3,*})
	REE(0.752 ^{1,*})				
	REE(0.656 ^{1,*})	RET(0.642 ^{1,***})	REHC(0.527 ^{1,***})		
SK	RET(0.915 ^{1,***})				REE(-0.275 ^{2,*}) REHC(-0.021 ^{3,*})
	REE(0.851 ^{1,*})				
	RET(0.915 ^{1,***})	REE(0.576 ^{1,*})			REHC(-0.021 ^{3,*})
EU	REHC(0.867 ^{1,**})	RET(0.089 ^{3,*})	REE(0.009 ^{3,*})		
	REE(0.936 ^{1,*})				
	REE(0.945 ^{1,*})	REHC(0.867 ^{1,**})	RET(0.089 ^{3,*})		

Note: 1 – “strong” effect (>0.35); 2 – “medium” effect (0.15–0.35); 3 – “small” effect (<0.15); *Denotes significance at 10% level, **5% level, ***1% level (p value, two-tailed).

From the SEM analysis carried out for each country and the EU to identify the influence by sector of the share of renewable energy consumption in total energy consumption on LGDP (Table 2), the following influence types are observed:

1. Significant positive impact:

first-position:

- REE→LGDP: AT, BE, DE, FR, HU, IE, LU, MT, NL, PL, PT, RO, SE, SI, EU;
- REHC→LGDP: BG, CY, CZ, DK, ES, FI, IT;
- RET→LGDP: EL, SK;

second-position:

- REE→LGDP: strong-BG, CZ, DK, FI, IT, SK; medium-CY, ES;
- REHC→LGDP: strong-AT, BE, FR, MT, NL, RO, EU; medium-PL; low-DE;
- RET→LGDP: strong-LU, PT, SE, SI; medium-HU;

third-position:

- REHC→LGDP: strong-LU, SE, SI; low-PT
- RET→LGDP: strong-NL, RO; medium-FR, IT, PL; low-BG, ES, EU.

2. Negative impact:

- REE→LGDP: strong-EL;
- REHC→LGDP: strong-IE; medium-EL, HU; low-SK;
- RET→LGDP: strong-IE, MT; medium-AT, BE, FI; low-CY, CZ, DE, DK.

After building the SEM models for each country and the EU, we constructed MLP-type ANNs with a single hidden layer associated with the financing mechanisms of RE_FEC. The predictors (the exogenous variables REE, REHC, and RET) are considered as inputs for the neural network that emphasizes the predicted variable influence (endogenous variable LGDP). Thus, the number input layers (number of predictors) is three, and the output layer is one (LGDP), as shown in Figure 5 where was presented ANN for the EU as an example.

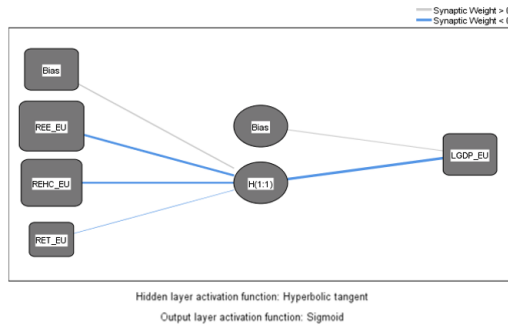

Figure 5. MLP network for EU

In the ANN construction, the automatic generation of the hidden layer is performed. The activation functions Sigmoid (for the output layer), respectively, Hyperbolic Tangent (for the hidden layer) were used because Relative Error and Sum of Squares Error recorded the lowest values. At EU level exists a direct influence between REE, REHC, RET and LGDP given by the synaptic weight. Based on the Bias parameter, it is found that the ANN built for the analyzed data fits best. The datasets are split into training (76.5%) and testing data (23.5%). The ANN prediction accuracy is evaluated by calculating RMSE for both datasets (ten runs). Also, the RMSE are nearly to 0, which shows high predictive accuracy and good data fit. The best model fit is ANN10 (Table 3).

For ANN10 for EU, the relative importance of each input predictor is calculated using sensitivity analysis (Figure 6).

Table 3. RMSE for the EU

Input: REE, REHC, RET Output: LGDP				
ANN	Training-data (76.5% of Dataset = 17, N = 13)		Testing-data (23.5% of Dataset = 17, N = 4)	
	SSE	RMSE	SSE	RMSE
1	0.107	0.0907	0.092	0.1517
2	0.092	0.0841	0.103	0.1605
3	0.118	0.0953	0.071	0.1332
4	0.041	0.0562	0.101	0.1589
5	0.064	0.0702	0.099	0.1573
6	0.032	0.0496	0.091	0.1508
7	0.074	0.0754	0.091	0.1508
8	0.058	0.0668	0.072	0.1342
9	0.079	0.0780	0.065	0.1275
10	0.032	0.0496	0.053	0.1151
	Average	0.0716	Average	0.1440

Thus, it is noted that the most significant predictor of LGDP is REE, followed by REHC, while RET has the weakest influence.

Similarly, ANNs were constructed for all countries, resulting in the same ranking obtained by SEM.

SEM and ANN for the EU and each country highlight the effect exerted by the three sectoral components REE, REHC, and RET on GDP, directly or indirectly and with different intensities from one country to another, results found and in other specialized research (Abbasi et al., 2021). The SEM-ANN integrated model validated the findings of the tested multifactorial linear regressions.

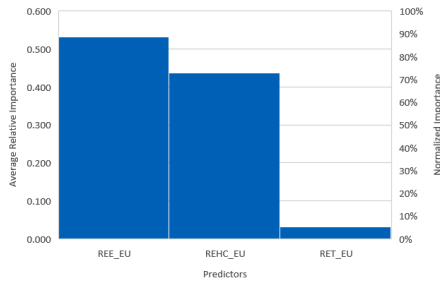

Figure 6. Normalized importance for the EU

The ANN study built for the analysis of RE_FEC at the sectorial level shows that REE, in the EU and most countries, has a strong or medium influence on GDP, results confirmed in similar studies (Xie et al., 2023; Abbasi et al., 2021).

Due to worldwide regulations regarding the necessity to increase REHC, countries have increased their consumption in this sector. Thus, in 20 countries and the EU, REHC consumption has an impact on GDP, findings are also found in other studies (Kim et al., 2020).

The impact of RET→GDP is determined by European Commission regulations and national energy policies to switch to green transport, results also found by other studies (Komarnicka & Murawska, 2021; Doytch & Narayan, 2021).

5. Conclusions

Much research was toward determining the RE_FEC impact on GDP, but no consensus has been reached regarding this relationship. Thus, this research primarily analyzed the correlation between RE_FEC and GDP by testing several regression models and fitting regression curves. In most countries, it was found that there is a long-term equilibrium relationship between the variables. Thus, there exists Granger causality between them. Also analyzed was relationship between REE, REHC, RET, and GDP. Then, we determined their influence on GDP in the EU and each country using SEM and ANN.

Both practical and theoretical implications emerge from this study. Given the need for sustainable development at the level of the European Union, they are relevant. By approaching the integrated SEM-ANN model, the study contributes to the specialized literature by more precisely identifying the significance of the relationships between REE, REHC, RET, and GDP. The model thus provides a new research paradigm for linear and nonlinear relationships.

From the perspective of practical relevance, this study demonstrates, both for the European Union and member countries, the importance of increasing the consumption of renewable energy, which has a significant influence on economic growth. Through the new provisions

of the European Union, at the level of economic sectors, the share of energy consumption from renewable sources in the total energy consumption until 2030 has new values. So, this research can be useful in national and European energy policy adoption, thus contributing to sustainable development. At the same time, it can be the basis for the measures adopted to support and stimulate deficit sectors.

Following this study, it found that in most EU countries, REE and REHC have a powerful direct influence and RET has a less significant impact on GDP. Thus, the EU countries are forced to realize that to increase the standard of living of the population, they must adopt consistent energy and economic policies that emphasize energy from renewable sources as an alternative to traditional fuels. The study also has some theoretical implications. First, renewable energy consumption's impact on economic growth is determined, both, at the EU level and in each member country. Secondly, the research contributes to the specialized literature through the neural network approach to establish the significance of the relationship between renewable energy consumption and economic growth. Thirdly, the impact of renewable energy consumption in the main sectors on economic growth was determined and ranked using the integrated SEM-ANN model. This is a novelty in the specialized literature.

The results of this study can be the basis for other research. It can be useful at the state level for the adoption of energy policy strategies in such a way as to stimulate the growth of renewable energy consumption in all sectors. At the same time, the findings can be the basis for the realization and implementation of programs to stimulate renewable energy consumption for unfavorable sectors so that as many states as possible reach the proposed targets by 2030.

Accelerating the growth of RE_FEC at the expense of non-renewable energy consumption generates substantial benefits in each European Union country's energy policy to achieve a sustainable economy and increase energy independence. Thus, this is a strong motivation for EU governments to support through various national policies the increase of the renewable energy consumption share in total energy consumption and to support this consumption rise, especially in RET and REHC. Following the research conducted in this study, the increase in RE_FEC will lead to GDP. At the same time, the Russian-Ukrainian conflict and the COVID-19 pandemic have shown the importance of energy independence, so states should not rely on fossil fuel sources and emphasize renewable energy sources. In these conditions, measures must be adopted at the level of the European Union to facilitate the production of energy from renewable sources and to move more and more from the consumption of energy from fossil fuels to the consumption of renewable energy, which will have positive implications in all economic sectors and will lead to economic growth.

However, the study also has certain limitations. It is made only on the states of the European Union, which provides information only for a specific type of country. The results may be irrelevant for countries on other continents. Thus, analyses of the impact of renewable energy consumption on the economic growth of different groups of states on each continent can be established as future research directions. Another limitation of the paper is given by the SEM construction method, which in the future may consider more prediction variables and the introduction of other exogenous variables with a mediating role into the structural model.

By introducing in the structural model other exogenous variables with a mediating role, the obtained results can be different and may allow the quantification of both direct and indirect effects. At the same time, another limitation comes from the chosen neural network model that has only one hidden layer with one neuron assigned to the financing mechanisms of RE_FEC. Thus, by using several hidden layers and adding new neurons, other economic

parameters can be taken into account to improve the performance of the MLP model. Starting from these limits, we consider as future research directions to use more complex SEM models and neural networks with more hidden layers.

Data availability

The datasets for the indicators were retrieved from Eurostat-Database:

https://appsso.eurostat.ec.europa.eu/nui/show.do?dataset=nama_10_gdp&lang=en;
https://ec.europa.eu/eurostat/databrowser/view/nrg_bal_c/default/table?lang=en;
<https://ec.europa.eu/eurostat/web/energy/data/energy-balances>;
https://ec.europa.eu/eurostat/databrowser/view/sdg_07_40/default/table?lang=en;
https://ec.europa.eu/eurostat/databrowser/view/sdg_07_40/default/table?lang=en;
https://ec.europa.eu/eurostat/databrowser/view/sdg_07_40/default/table?lang=en.

Funding

This work was supported by research funds of University of Craiova.

Author contributions

All authors have contributed significantly to this research in all phases and sections.

Disclosure statement

The authors declare that they have no competing financial, professional, or personal interests from other parties.

References

- Abbasi, K. R., Abbas, J., & Tufail, M. (2021). Revisiting electricity consumption, price, and real GDP: A modified sectoral level analysis from Pakistan. *Energy Policy*, 149, Article 112087. <https://doi.org/10.1016/j.enpol.2020.112087>
- Ahmed, M. M., & Shimada, K. (2019). The effect of renewable energy consumption on sustainable economic development: Evidence from emerging and developing economies. *Energies*, 12(15), Article 2954. <https://doi.org/10.3390/en12152954>
- Alam, M. M., & Murad, M. W. (2020). The impacts of economic growth, trade openness and technological progress on renewable energy use in organization for economic cooperation and development countries. *Renewable Energy*, 145, 382–390. <https://doi.org/10.1016/j.renene.2019.06.054>
- Albahri, A. S., Alnoor, A., Zaidan, A. A., Albahri, O. S., Hameed, H., Zaidan, B. B., Peh, S. S., Zain, A. B., Siraj, S. B., Masnan, A. H. B., & Yass, A. A. (2022). Hybrid artificial neural network and structural equation modelling techniques: a survey. *Complex & Intelligent Systems*, 8, 1781–1801. <https://doi.org/10.1007/s40747-021-00503-w>
- Anton, S. G., & Afloarei Nucu, A. E. (2020). The effect of financial development on renewable energy consumption. A panel data approach. *Renewable Energy*, 147(1), 330–338. <https://doi.org/10.1016/j.renene.2019.09.005>
- Burke, P. J., Stern, D. I., & Bruns, S. B. (2018). The impact of electricity on economic development: A macroeconomic perspective. *International Review of Environmental and Resource Economics*, 12(1), 85–127. <https://doi.org/10.1561/101.00000101>

- Chen, C., Pinar, M., & Stengos, T. (2020). Renewable energy consumption and economic growth nexus: Evidence from a threshold model. *Energy Policy*, 139, Article 111295. <https://doi.org/10.1016/j.enpol.2020.111295>
- Chen, Y. Y., Mamon, R., Spagnolo, F., & Spagnolo, N. (2023). Sustainable developments, renewable energy, and economic growth in Canada. *Sustainable Development*, 31(4), 2950–2966. <https://doi.org/10.1002/sd.2561>
- Doytch, N., & Narayan, S. (2021). Does transitioning towards renewable energy accelerate economic growth? An analysis of sectoral growth for a dynamic panel of countries. *Energy*, 235, Article 121290. <https://doi.org/10.1016/j.energy.2021.121290>
- European Environment Agency. (2022). *Primary and final energy consumption in Europe*. <https://www.eea.europa.eu/data-and-maps/indicators/final-energy-consumption-by-sector-13>
- El-Karimi, M. (2021). Investigating the causal linkage among economic growth and renewable and non-renewable energy consumption: Cases of Germany, UK and France. *OPEC Energy Review*, 45(4), 414–437. <https://doi.org/10.1111/opec.12215>
- Directive 2009/28/EC. *Directive 2009/28/EC of the European Parliament and of the Council of 23 April 2009 on the promotion of the use of energy from renewable sources and amending and subsequently repealing Directives 2001/77/EC and 2003/30/EC*. <https://eur-lex.europa.eu/legal-content/en/ALL/?uri=CELEX%3A32009L0028>
- European Commission. (2022). *Heating and cooling*. https://energy.ec.europa.eu/topics/energy-efficiency/heating-and-cooling_en
- European Commission. (2021). *Revision of the Renewable Energy Directive: The EU's plan for a green transition. European Green Deal and Fit for 55 package*. <https://www.consilium.europa.eu/en/policies/green-deal/fit-for-55-the-eu-plan-for-a-green-transition/>
- Eurostat. (2022a). *Complete energy balances*. https://ec.europa.eu/eurostat/databrowser/view/nrg_bal_c/default/table?lang=en
- Eurostat. (2022b). *Energy consumption in households (europa.eu)*. https://ec.europa.eu/eurostat/statistics-explained/index.php?title=Energy_consumption_in_households
- Fashina, O. A., Asaley, A. J., Ogunjobi, J. O., & Lawal, A. I. (2018). Foreign aid, human capital and economic growth nexus: Evidence from Nigeria. *Journal of International Studies*, 11(2), 104–117. <https://doi.org/10.14254/2071-8330.2018/11-2/8>
- Fayaz, M., & Kim, D. (2018). A prediction methodology of energy consumption based on deep extreme learning machine and comparative analysis in residential buildings. *Electronics*, 7(10), Article 222. <https://doi.org/10.3390/electronics7100222>
- Furuoka, F. (2017). Renewable electricity consumption and economic development: New findings from the Baltic countries. *Renewable And Sustainable Energy Reviews*, 71, 450–463. <https://doi.org/10.1016/j.rser.2016.12.074>
- Gong, W., Tang, L., Chen, Y., & Cheng, Z. (2023). Application of an artificial neural network model based on mineral composition to the prediction of physical and mechanical properties. *Applied Sciences*, 13, Article 7690. <https://doi.org/10.3390/app13137690>
- Guliyev, H., & Tatoğlu, F. Y. (2023). The relationship between renewable energy and economic growth in European countries: Evidence from panel data model with sharp and smooth changes. *Renewable Energy Focus*, 46, 185–196. <https://doi.org/10.1016/j.ref.2023.06.005>
- Hair, J. F., Black, W. C., Babin, B. J., & Anderson, R. E. (2010). *Multivariate data analysis* (7th ed.). Pearson.
- Hair, J. F., Ringle, C. M., & Sarstedt, M. (2013). Partial least squares structural equation modeling: Rigorous applications, better results and higher acceptance. *Long Range Planning*, 46(1–2), 1–12. <https://doi.org/10.1016/j.lrp.2013.01.001>
- Hinov, N., Dimitrov, V., & Vacheva, G. (2021). Model for vehicle to home system with additional energy storage for households. *Electronics*, 10(9), Article 1085. <https://doi.org/10.3390/electronics10091085>
- Hu, L. T., & Bentler, P. M. (1999). Cutoff criteria for fit indexes in covariance structure analysis: Conventional criteria versus new alternatives. *Structural Equation Modeling*, 6(1), 1–55. <https://doi.org/10.1080/10705519909540118>
- IEA. (2022). *Energy and Climate Change. World Energy Outlook – The IEA's outlook to 2040*. <https://www.woodmac.com/news/opinion/the-ieas-outlook-to-2040/>

- Inês, C., Guilherme, P. L., Esther, M. G., Swantje, G., Stephen, H., & Lars, H. (2020). Regulatory challenges and opportunities for collective renewable energy prosumers in the EU. *Energy Policy*, 138, Article 111212. <https://doi.org/10.1016/j.enpol.2019.111212>
- Ivanovski, K., Hailemariam, A., & Smyth, R. (2021). The effect of renewable and nonrenewable energy consumption on economic growth: non-parametric evidence. *Journal of Cleaner Production*, 286, Article 124956. <https://doi.org/10.1016/j.jclepro.2020.124956>
- Jia, H., Fan, S., & Xia, M. (2023). The impact of renewable energy consumption on economic growth: Evidence from countries along the belt and road. *Sustainability*, 15, Article 8644. <https://doi.org/10.3390/su15118644>
- Khrībich, A., Kacem, R. H., & Dakhloui, A. (2021). Causality nexus of renewable energy consumption and social development: Evidence from high-income countries. *Renewable Energy*, 169, 14–22. <https://doi.org/10.1016/j.renene.2021.01.005>
- Kim, S., Choi, I., Kim, D., & Lee, M. (2020). Deep neural network based ambient airflow control through spatial learning. *Electronics*, 9(4), Article 591. <https://doi.org/10.3390/electronics9040591>
- Komarnicka, A., & Murawska, A. (2021). Comparison of consumption and renewable sources of energy in European Union countries – sectoral indicators, economic conditions and environmental impacts. *Energies*, 14(12), Article 3714. <https://doi.org/10.3390/en14123714>
- Krkošková, R. (2021). Causality between energy consumption and economic growth in the V4 countries. *Technological and Economic Development of Economy*, 27(4), 900–920. <https://doi.org/10.3846/tede.2021.14863>
- Li, F., Lu, S., Cao, C., & Feng, J. (2021). Operation optimization of regional integrated energy system considering the responsibility of renewable energy consumption and carbon emission trading. *Electronics*, 10(21), Article 2677. <https://doi.org/10.3390/electronics10212677>
- Mohsin, M., Naseem, S., Sarfraz, M., & Azam, T. (2022). Assessing the effects of fuel energy consumption, foreign direct investment and GDP on CO₂ emission: New data science evidence from Europe & Central Asia. *Fuel*, 314, Article 123098. <https://doi.org/10.1016/j.fuel.2021.123098>
- Mughal, N., Arif, A., Jain, V., Chupradit, S., Shabbir, M. S., Ramos-Meza, C. S., & Zhanbayev, R. (2022). The role of technological innovation in environmental pollution, energy consumption and sustainable economic growth: Evidence from South Asian economies. *Energy Strategy Reviews*, 39, Article 100745. <https://doi.org/10.1016/j.esr.2021.100745>
- Nguyen, K. H., & Kakinaka, M. (2019). Renewable energy consumption, carbon emissions, and development stages: some evidence from panel cointegration analysis. *Renewable Energy*, 132, 1049–1057. <https://doi.org/10.1016/j.renene.2018.08.069>
- Odugbesan, J. A., & Rjoub, H. (2020). Relationship among economic growth, energy consumption, CO₂ emission, and urbanization: Evidence from MINT Countries. *SAGE Open*, 10, 1–15. <https://doi.org/10.1177/2158244020914648>
- Ooi, K. B., & Tan, G. W. H. (2016). Mobile technology acceptance model: An investigation using mobile users to explore smartphone credit card. *Expert Systems with Applications*, 59, 33–46. <https://doi.org/10.1016/j.eswa.2016.04.015>
- Pan, X., Shao, T., Zheng, X., Zhang, Y., Ma, X., & Zhang, Q. (2023). Energy and sustainable development nexus: A review. *Energy Strategy Reviews*, 47, Article 101078. <https://doi.org/10.1016/j.esr.2023.101078>
- Pejovic, B., Karadzic, V., Dragasevic, Z., & Backovic, T. (2021). Economic growth, energy consumption and CO₂ emissions in the countries of the European Union and the Western Balkans. *Energy Reports*, 7, 2775–2783. <https://doi.org/10.1016/j.egy.2021.05.011>
- Radmehr, R., Henneberry, S. R., & Shayanmehr, S. (2021). Renewable energy consumption, CO₂ emissions, and economic growth nexus: A simultaneity spatial modeling analysis of EU countries. *Structural Change and Economic Dynamics*, 57, 13–27. <https://doi.org/10.1016/j.strueco.2021.01.006>
- Šikić, T. F. (2020). The impact of energy consumption on economic growth in developed and post-transition countries of European Union. *Zbornik Radova Ekonomskog Fakulteta u Rijeci*, 38, 475–497. <https://doi.org/10.18045/zbefri.2020.2.475>

Simionescu, M., Strielkowski, W., & Tvaronavičiene, M. (2020). Renewable energy in final energy consumption and income in the EU-28 countries. *Energies*, 13(9), Article 2280.

<https://doi.org/10.3390/en13092280>

Ullman, J. B. (2001). Structural equation modelling. In B. G. Tabachnick, & L. S. Fidell (Eds.), *Using multivariate statistics* (4th ed.). Pearson Education.

Xie, P., Zhu, Z., Hu, G., & Huang, J. (2023). Renewable energy and economic growth hypothesis: Evidence from N-11 countries. *Economic Research-Ekonomska Istraživanja*, 36(1), Article 2121741.

<https://doi.org/10.1080/1331677X.2022.2121741>

APPENDIX

Table A1. Linear regression coefficients

Co.	R ²	SER	Prob	(Constant)			LRE_FEC		
				Coef	SE	Prob	Coef	SE	Prob
AT	0.674	0.087	0.000***	6.222	1.156	0.000***	0.782	0.140	0.000***
BE	0.842	0.059	0.000***	10.732	0.238	0.000***	0.295	0.033	0.000***
BG	0.829	0.012	0.000***	1.678	0.080	0.000***	0.098	0.011	0.000***
CY	0.845	0.052	0.000***	8.597	0.137	0.000***	0.265	0.029	0.000***
CZ	0.856	0.089	0.000***	5.405	0.698	0.000***	0.845	0.090	0.000***
DE	0.564	0.096	0.001***	9.317	1.254	0.000***	0.576	0.131	0.001***
DK	0.861	0.050	0.000***	7.734	0.490	0.000***	0.652	0.068	0.000***
EL	0.422	0.008	0.005***	2.815	0.095	0.000***	-0.04	0.013	0.005***
ES	0.822	0.056	0.000***	-51.27	54.298	0.361	14.03	12.638	0.286
FR	0.808	0.046	0.000***	9.626	0.619	0.000***	0.523	0.066	0.000***
FI	0.807	0.056	0.000***	5.777	0.811	0.000***	0.752	0.095	0.000***
HU	0.253	0.139	0.040**	9.789	0.8	0.000***	0.242	0.107	0.040**
IE	0.643	0.182	0.000***	8.516	0.726	0.000***	0.657	0.126	0.000***
IT	0.729	0.029	0.000***	13.124	0.187	0.000***	0.132	0.021	0.000***
LU	0.880	0.090	0.000***	8.833	0.182	0.000***	0.415	0.040	0.000***
MT	0.881	0.014	0.000***	2.160	0.005	0.000***	0.022	0.002	0.000***
NL	0.951	0.027	0.000***	11.099	0.135	0.000***	0.327	0.019	0.000***
PL	0.771	0.130	0.000***	5.998	0.963	0.000***	0.794	0.112	0.000***
PT	0.392	0.072	0.007***	6.935	1.659	0.001***	0.655	0.211	0.007***
SE	0.945	0.040	0.000***	7.231	0.355	0.000***	0.647	0.040	0.000***
SK	0.650	0.016	0.000***	2.060	0.066	0.000***	0.056	0.011	0.000***
EU	0.913	0.037	0.000***	9.090	0.572	0.000***	0.633	0.050	0.000***

Note: *Denotes significance at 10% level, **5% level, ***1% level; SE-Standard Error; Prob-Probability.

Table A2. Multifactorial linear regression estimated coefficients

Co.	Multiple Linear Regression			(Constant)			REE			
							REHC			
	R ²	SER	Prob	Coef	SE	Prob	RET			VIF
							Coef	SE	Prob	
AT	0.95	0.04	0.0***	10.96	0.18	0.0***	0.02	0.01	0.001***	4.416
							0.02	0.06	0.006***	4.892
							-0.80	0.01	0.098*	4.900
BE	0.97	0.03	0.0***	12.49	0.03	0.0***	0.02	0.01	0.000***	9.034
							0.04	0.01	0.001***	4.399
							-0.20	0.01	0.041**	3.488
BG	0.88	0.12	0.0***	9.68	0.14	0.0***	-0.10	0.04	0.093*	9.110
							0.05	0.02	0.052*	4.314
							0.01	0.03	0.084*	3.585
CY	0.81	0.06	0.0***	9.46	0.06	0.0***	-0.20	0.01	0.028**	6.444
							0.02	0.01	0.000***	4.807
							-0.10	0.01	0.085*	1.280
CZ	0.82	0.11	0.0***	11.02	0.20	0.0***	-0.20	0.02	0.094*	9.855
							0.07	0.03	0.012**	4.724
							-0.10	0.02	0.095*	3.371
DE	0.97	0.03	0.0***	14.49	0.05	0.0***	0.012	0.01	0.000***	8.855
							0.01	0.01	0.065*	4.884
							-0.10	0.01	0.093*	2.820
DK	0.98	0.02	0.0***	11.94	0.04	0.0***	0.02	0.01	0.082*	9.921
							0.02	0.01	0.000***	4.975
							-0.10	0.01	0.099*	4.076
EL	0.76	0.07	0.0***	12.45	0.08	0.0***	-0.20	0.01	0.092*	9.018
							-0.10	0.01	0.076*	4.932
							0.05	0.02	0.043**	2.869
ES	0.69	0.06	0.0***	13.53	0.09	0.0***	-0.10	0.01	0.059*	9.098
							0.04	0.02	0.048**	4.332
							0.01	0.01	0.095*	1.475
FI	0.932	0.04	0.0***	11.19	0.1	0.0***	-0.10	0.01	0.083*	8.948
							0.02	0.01	0.001***	4.722
							-0.10	0.01	0.075*	3.512
FR	0.88	0.04	0.0***	14.14	0.06	0.0***	0.01	0.01	0.089*	9.581
							0.02	0.02	0.082*	4.587
							0.01	0.01	0.071*	3.088
HU	0.73	0.09	0.0***	11.27	0.12	0.0***	0.05	0.03	0.095*	5.947
							-0.10	0.01	0.087*	3.488
							0.01	0.03	0.075*	4.367

End of Table A2

Co.	Multiple Linear Regression			(Constant)			REE			
							REHC			
	RET				VIF					
	R ²	SER	Prob	Coef		SE	Prob	Coef	SE	Prob
IE	0.85	0.13	0.0***	11.71	0.24	0.0***	0.07	0.03	0.010***	9.359
							-0.80	0.07	0.076*	4.478
							-0.30	0.07	0.097*	4.352
IT	0.74	0.03	0.0***	14.15	0.04	0.0***	-0.10	0.01	0.076*	5.117
							0.01	0.01	0.020**	4.308
							0.01	0.01	0.052*	4.369
LU	0.82	0.12	0.0***	10.38	0.16	0.0***	-0.30	0.04	0.068*	9.713
							0.04	0.07	0.057*	3.733
							0.06	0.04	0.092*	4.344
MT	0.97	0.07	0.0***	8.58	0.03	0.0***	0.09	0.03	0.004***	9.875
							0.03	0.01	0.001***	3.324
							-0.60	0.03	0.095*	4.732
NL	0.91	0.04	0.0***	13.15	0.03	0.0***	-0.10	0.01	0.084*	9.131
							0.05	0.02	0.027**	4.287
							0.04	0.01	0.091*	4.548
PL	0.87	0.11	0.0***	12.21	0.12	0.0***	0.03	0.01	0.019**	7.622
							0.02	0.01	0.059*	3.878
							0.03	0.02	0.096*	3.571
PT	0.81	0.04	0.0***	11.85	0.21	0.0***	0.01	0.01	0.075*	2.568
							0.01	0.01	0.075*	4.781
							0.02	0.01	0.019**	3.357
RO	0.75	0.19	0.0***	10.32	0.45	0.0***	0.07	0.02	0.088*	6.047
							0.04	0.02	0.037**	1.945
							0.06	0.04	0.086*	4.595
SE	0.87	0.07	0.0***	12.08	0.36	0.0***	-0.10	0.01	0.072*	9.587
							0.02	0.01	0.031**	4.313
							0.01	0.01	0.073*	4.084
SI	0.78	0.08	0.0***	10.00	0.38	0.0***	-0.10	0.02	0.075*	3.191
							0.02	0.01	0.012**	1.952
							0.04	0.01	0.003***	2.398
SK	0.88	0.11	0.0***	10.81	0.48	0.0***	-0.30	0.04	0.084*	6.596
							-0.10	0.01	0.089*	3.463
							0.15	0.04	0.008***	4.951
EU	0.93	0.04	0.0***	15.69	0.14	0.0***	0.50	0.07	0.098*	9.835
							0.03	0.02	0.077*	4.625
							0.01	0.02	0.083*	3.253

Note: *Denotes significance at 10% level, **5% level, ***1% level.