



## COPULA EFFECT ON INVESTMENT PORTFOLIO OF AN INSURANCE COMPANY

Henrikas Pranevičius<sup>1</sup>, Kristina Štutienė<sup>2\*</sup>

*Kaunas University of Technology, Department of Business Informatics,  
Studentų g. 56-301, 51424 Kaunas, Lithuania,  
Phone +370(681)52842, fax. +370(37)451654  
E-mails: <sup>1</sup>hepran@vik.ktu.lt; <sup>2</sup>kristina.sutiene@ktu.lt*

*\* Corresponding author*

*Received 6 April 2008; accepted 5 September 2008*

**Abstract.** For an insurance company, the planning has to be carried out under uncertainty. Thus, the decision making model includes the parameters that are not completely known at the current point of time, when the decision has to be taken. These parameters can be named as risk factors. The activity of insurance company is affected by many risk factors, thus the multivariate uncertainty space, where the correlations among these factors are possible, can be constructed. For their dependency structure, the alternative method – copula functions – are employed, which allows to model the non-linear dependencies between the correlated stochastic variables. The purpose of this work is to explore the copula effect on the investment portfolio of the insurance company. The insurance business is influenced by a large number of stochastic parameters, and decisions concerning the assets that must be invested over time to cover liabilities and to achieve goals subject to various uncertainties and various constraints are considered. Two approaches of making decision models under uncertainty are applied in the integrated dynamic management of insurance company's financial assets and liabilities. One of them allows to evaluate the company's strategy and technically is based on stochastic simulation. The other approach generates a strategy from the stochastic optimization model. Two copula functions – Gaussian copula and Student's t-copula – concerning the investment performance are employed while generating the set of scenarios for representing the behaviour of risk factors in the multivariate structure.

**Keywords:** stochastic simulation, stochastic optimization, scenario generation, decision-making, copula function, investment portfolio, asset liability management, insurance.

**Reference** to this paper should be made as follows: Pranevičius, H.; Štutienė, K. 2008. Copula effect on investment portfolio of an insurance company, *Technological and Economic Development of Economy* 14(3): 344–373.

### 1. Introduction

Decision-making under uncertainty is one of the foremost challenges for any financial institution. This is especially true for dynamic decision problems, where the uncertainty is

related to the future realizations of certain key variables. Financial institutions, like insurance companies, need effective strategic planning for management of their financial resources and liabilities in stochastic environments, with market, economic and actuarial risks all playing an important role. (Dempster *et al.* 2003).

The insurance business is twofold. It includes: (a) the underwriting activity, which is mainly concentrated on collecting premiums and exploring the losses distribution; (b) the investment activity, which is aimed to allocate free resources into various investments and to earn additional revenues. Both activities are related and subject to the risk factors (Ziembra 2003). In a multivariate structure of uncertainty, the correlations among risk factors (contemporaneous dependency) and correlations in time (intertemporal dependency) are possible. The good methods are needed to describe this dependency structure which is far from linear type. Besides, the distributions of risk factors rarely are of Gaussian type. In this paper, the alternative method – copula function – is applied to describe the dependency structure of non-linear type among non-normally distributed stochastic variables (Embrechts *et al.* 2002; Nelsen 2006; Aas 2004). Since the scenarios are generated to represent the evolution of risk factors in future, the features of copula functions have to be reflected in the generated scenarios set. In this context, the algorithm how to incorporate copula functions in the scenarios set was developed (Pranevičius and Štutienė 2006, 2007).

The generated scenarios set with the included copula functions is the input to the decision-making model. Thus, it is natural to explore what is the copula effect on the output of decision-making model. For this purpose, two different approaches of the same underlying decision problem – investment portfolio management under uncertainty – are quantitatively compared. The first is based on decision-making using stochastic simulation model, while the other is a multistage stochastic programming (optimization) approach. In comparing the stochastic simulation and stochastic programming (optimization) approaches, it is important to note that the former allows to find the decision that is the best one from the set of tested alternative decisions, using the efficient frontier concept, while the latter allows to obtain the optimal decision subject to some restrictions and constraints under which the relevant system must operate.

The basic dynamic decision-making problem under uncertainty treated in this paper is: to invest the premiums and previous earnings from investments to yield good asset returns over time and to provide resources for insurance claims. These claims have distributions of losses, as with typical liabilities (Ziembra 2003). Scenarios are generated to represent the future paths for liabilities derived from the underwriting business and the future paths for asset variables subject to the investment activity. Hence, they are classical asset liability enterprises seeking the methods for the best or optimal management of their resources.

Asset liability modelling and management models usually require knowledge from different fields such as statistics, economics, financial mathematics and optimization. In a schematic and generic way, the different elements of asset liability models can be organized along 3 separate poles of interest and a common set of structural considerations (Collomb 2004). The first task is to declare the future asset and liability cash flows that are to be expected. Then, it is needed to set the objectives of an organization (or an individual). The final task is to choose the set of possible investment vehicles that we want to include in the decision-making process. Such structure creates a framework for decision-making under uncertainty (Fig. 1).

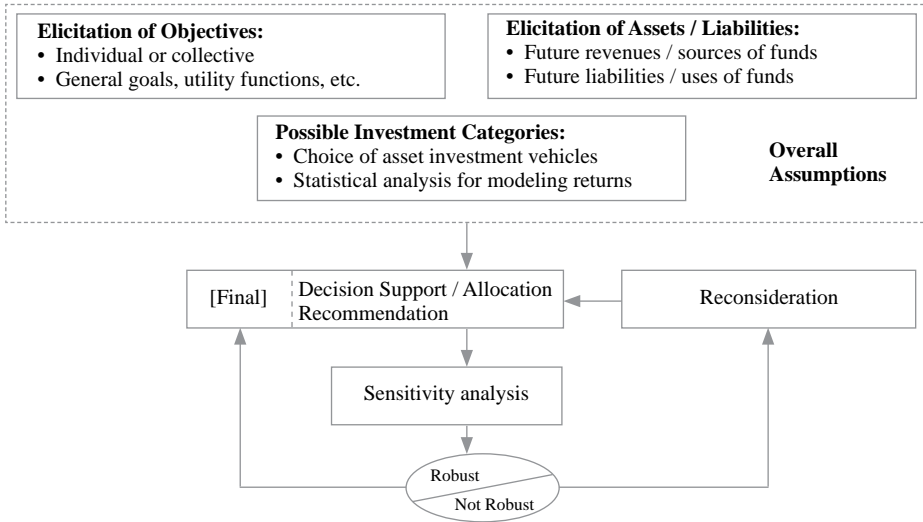

Fig. 1. Decision-making framework for asset liability management

The paper is organized as follows. In Section 2 the current research area in creating planning models under uncertainty in insurance business is described. The concepts of modelling the multivariate dependency structure through copulas are described in Section 3. Two copulas – Gaussian and Student’s – are presented. In Section 4 the role of scenarios and the different structures of scenarios are described. The main features of decision simulator are described in Section 5. The conceptual and formal models of decision-making concerning the investment activity in insurance business are described in Section 6. Finally, two considered approaches are compared by the application of investment portfolio selection and the effect of copula function is explored.

## 2. Short overview of decision-making models

Since the insurance business is particularly subject to the risk, the decisions that hedge the risk rising from environment are needed for insurance company itself in achieving the profit and at the same time ensuring the protection of its clients from the risk. That’s why the methodology to support the decisions in insurance operations is a very intensive research area (Beusekom-Bastiaans 2005; Shiu 2006; Kouwenberg and Zenios 2006). The appropriate decisions have to be made concerning the underwriting and investment business. In the literature two main directions exist that can be applied for the case of insurance company management:

- strategy evaluation which allows to choose the ‘best’ decision (Kaufmann *et al.* 2001; Lowe and Stanard 1997; Nobles 2007),
- strategy generation which allows to choose the optimal decision (Pirbhai *et al.* 2003; Yu *et al.* 2003).

The popular models are based on the methodology, known as Dynamic Financial Analysis (DFA), which belongs to the first group of decision-making models. Since this approach lacks the optimization capabilities, the other technique – Stochastic Programming (SP), which belongs to the second group of decision-making models, is often used. Both tasks are not trivial, because these models incorporate the uncertainty which is represented by a high number of scenarios.

The use of copulas to describe the non-linear dependency structure among correlated non-normally distributed stochastic variables is rather a new approach (Embrechts *et al.* 2002; Nelsen 2006; Aas 2004). For a decision-making model, the copulas have to be incorporated in the scenarios set, which is used as an input to this model. At the current time, the copulas are popular in risk management field (Kole *et al.* 2007; Rosenberg and Schuermann 2006; Pfeifer and Nešlehová 2003), where the models for representing the behaviour of risk factors are established. There exist some applications of copulas into integrated dynamic decision models established based on DFA concept (Eling and Toplek 2007; Nicholls and Skinner 2007). But the researches of applications of copula functions into decision-making model based on SP concept are missing. The reason is that SP models are often computationally intractable and must be approximated by a problem of smaller dimension. Here comes a need to construct the scenarios tree for representing the underlying uncertainty. In this context, in the paper (Kaut and Wallace 2006), it is argued that it is rather complicated to generate a scenario tree with implemented particular copula function for dependent stochastic variables. In their paper, the moment matching method was used to generate copula-based scenarios. But this research field is still missing good methods, how to implement copula functions while generating the scenarios tree for dependent risk factors. In the case of successful implementation of copula in the structure of scenario tree, researches how the copula function affects the optimal decisions, generated from SP model, can be performed.

### **3. Multivariate dependency structure through copulas**

#### **3.1. Issues with traditional approach**

The traditional approach uses Pearson linear coefficient to measure dependent risks. It is assumed that random variables are linearly dependent and that the underlying univariate marginal distributions are normally distributed. The modelling of dependent variables is performed employing the Pearson's correlation matrix to describe the multivariate structure. The basic linear correlation coefficient works well with multivariate Gaussian distribution. In practice, most financial and actuarial risks are usually heavy tailed: catastrophe claims are often modelled using Lognormal or Gamma distribution, stock prices are assumed to be log-normally distributed. In a paper (Wirch 1999), it is argued that it is practically rare to find portfolios that had avoided high-end risk to the point that the tails of the loss distribution can be compared to that of the normal. Thus, the assumption of normality can underestimate or overestimate the actual risk distributions.

The paper (Embrechts *et al.* 1999) demonstrates how linear correlation coefficient can be a source of confusion. The authors show that it is possible to have two different multivariate

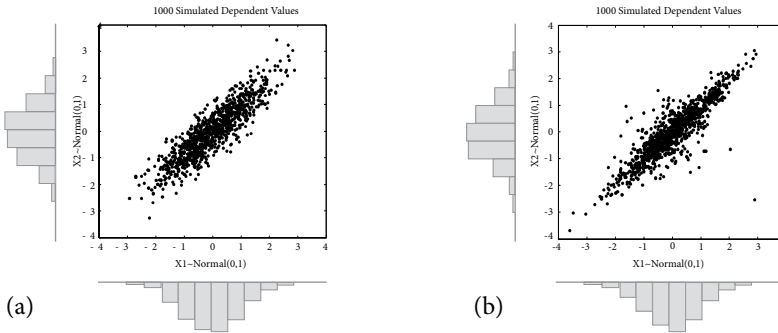

Fig. 2. Different dependency structures between  $X_1$  and  $X_2$  with  $\rho = 0,7$

distributions with the same marginal distributions and the same linear correlation coefficient, but with quite different dependencies. We include Fig. 2 as illustration of the given motivation in their paper.

Fig. 2 shows 1000 random variates from two distributions with identical standard Gaussian marginal distributions: case (a) and case (b) depict bivariate structure of  $X_1$  and  $X_2$  with linear correlation coefficient  $\rho = 0,7$ . However, the dependency structure between  $X_1$  and  $X_2$  is qualitatively quite different. It relates that in case (b) extreme values have a tendency to occur together. This example shows that the dependency between random variables cannot be distinguished on the grounds of correlation alone.

To overcome the limitations of correlation, the practitioners can draw on copula functions. It is very powerful technique, which allows to represent the joint distribution by splitting marginal behaviour, embedded in the marginal distributions, from the dependency, captured by the copula itself. This superiority of using copulas releases the modelling and estimation of dependent random variables.

### 3.2. The concept of copula

Employing the Monte Carlo technique for simulation of random variable  $X$ , a random uniform  $u$  number from  $U \sim \text{Uniform}(0,1)$  is generated and then the inversion of  $u$  by  $x = F_X^{-1}(u)$  is performed. If we have  $d$  variables,  $(X_1, X_2, \dots, X_d)$ , we need  $d$  uniform random variables,  $(U_1, U_2, \dots, U_d)$ . If variables  $(X_1, X_2, \dots, X_d)$  are independent or correlated, then we need  $d$  independent or correlated uniform random variables,  $(U_1, U_2, \dots, U_d)$ , respectively. Thus, in multivariate structure, the dependency structure of the variables  $(X_1, X_2, \dots, X_d)$  is completely determined by the correlation structure of the uniform random variables,  $(U_1, U_2, \dots, U_d)$  (Wang 1997).

Let define the copula itself. A copula is defined as the joint cumulative distribution function of  $d$  uniform random variables

$$C(u_1, u_2, \dots, u_d) = \Pr(U_1 \leq u_1, U_2 \leq u_2, \dots, U_d \leq u_d).$$

A function  $C$  is the  $d$  -dimensional copula if it fulfils the following properties (Embrechts *et al.* 2002):

- The domain of  $C$  is  $[0,1]^d$  ;
- $C$  is grounded and  $d$  is increasing.

The margins  $C_k$  of  $C$  satisfy  $C_k(u) = u$  ,  $k = 1, 2, \dots, d$  for all  $u$  in  $[0,1]$  .

Let consider  $d$  random variables  $(X_1, X_2, \dots, X_d)$  with multivariate distribution  $F$  and univariate margins  $F_1(x_1), F_2(x_2), \dots, F_d(x_d)$  . Sklar’s theorem, which is the foundation for copulas, states that any joint distribution can be written in a copula form.

**Sklar’s theorem** (1959) (Nelsen 2006). Given a joint distribution function  $F(x_1, x_2, \dots, x_d)$  for random variables  $(X_1, X_2, \dots, X_d)$  with marginals  $(F_1, F_2, \dots, F_d)$  ,  $F$  can be written as a function of its marginals:

$$F(x_1, x_2, \dots, x_d) = C(F_1(x_1), F_2(x_2), \dots, F_d(x_d)),$$

where copula  $C(u_1, u_2, \dots, u_d)$  is a joint distribution with uniform marginals. Moreover, if each  $F_i$  is continuous,  $C$  is unique.

The dependency structure can be represented by a proper copula function. Moreover, the following corollary is attained from Sklar’s theorem.

**Corollary.** Let  $F$  be an  $d$  -dimensional distribution function with continuous margins  $(F_1(x_1), F_2(x_2), \dots, F_d(x_d))$  and copula  $C$ . Then, for any  $u = (u_1, u_2, \dots, u_d)$  in  $[0,1]^d$  :

$$C(u_1, u_2, \dots, u_d) = F(F_1^{-1}(u_1), F_2^{-1}(u_2), \dots, F_d^{-1}(u_d)),$$

where  $F_i^{-1}$  is the generalized inverse of  $F_i$  .

Many copulas with differing characteristics are available that lead to the different relationships among variables (Embrechts *et al.* 2002; Nelsen 2006). Copulas differ not so much in the association degree they provide, but rather in which part of the distributions the association is the strongest. One such measure is tail dependency which is an issue of the following section.

### 3.3. Two instances of copula functions

Gaussian copula is implied by a well-known multivariate distribution function: multivariate Gaussian distribution. A complete copula-based joint distribution can be constructed using assessed rank-order correlations and marginal distributions. Examples of rank-order correlations are Spearman’s rank  $\rho^{rank}$  and Kendall’s tau  $\rho^{\tau au}$  correlations, which are used to describe the dependency relations of a monotonic nature: it indicates the tendency of two random variables to increase/decrease concomitantly (positive dependency) or contrariwise (negative dependency). The relation between Kendall’s tau and Pearson’s rho  $\rho$  correlation coefficients is given by:

$$\rho_{ij}^{\tau au} = \frac{2}{\pi} \arcsin(\rho_{ij}), \quad i, j = \overline{1, d},$$

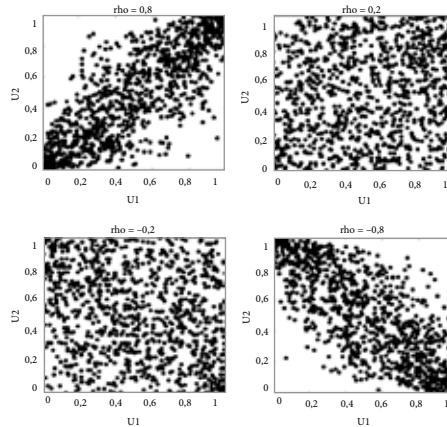

Fig. 3. Gaussian dependency structures with different correlation coefficients

between Spearman’s rank and Pearson’s rho correlation coefficients is given by:

$$\rho_{ij}^{rank} = \frac{6}{\pi} \arcsin \left( \frac{\rho_{ij}}{2} \right), \quad i, j = \overline{1, d}.$$

The Gaussian or Normal  $d$ -copula is given by:

$$C_{Cor}^{Ga}(u) = \Phi_{Cor}^d \left( \Phi^{-1}(u_1), \Phi^{-1}(u_2), \dots, \Phi^{-1}(u_d) \right),$$

where  $\Phi(x) = \int_{-\infty}^x e^{-t^2/2} dt$  denotes the standard univariate function and  $\Phi_{Cor}^d$  denotes the standard multivariate normal distribution function with matrix  $Cor = (\rho_{ij})$ ,  $i, j = \overline{1, d}$  of linear correlation coefficients.

Fig. 3 shows four scatter plots of 1000 random values from a bivariate Gaussian copula for various levels of correlation coefficient to illustrate the range of different dependency structures.

The main property of such dependency structure is that Gaussian copula does not have neither upper nor lower tail dependency, i.e. the coefficients of lower tail and upper tails dependency are  $\lambda_U(X_1, X_2) = \lambda_L(X_1, X_2) = 0$  (Aas 2004). It means that regardless of high correlation  $\rho_{12}$  is chosen, extreme events appear to occur independently in the tails of  $X_1$  and  $X_2$ .

Student’s t-copula is implied by multivariate Student’s t distribution, as it was for a Gaussian copula. The main difference of Student’s t-copula is that the Student’s t-dependency structure supports joint extreme movements regardless of the marginal behaviour of stochastic variable compared with the Gaussian copula. A complete copula-based joint distribution can be constructed using assessed rank-order correlations and marginal distributions, as it was for a Gaussian copula. Besides, the Student’s t-dependency structure introduces an additional parameter compared with the Gaussian copula, namely the degrees of freedom  $\nu$ . Student’s t-copula can be written as

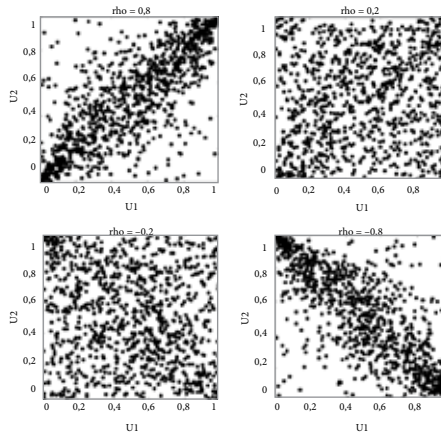

Fig 4. Student's t-dependency structures with different correlation coefficients and  $v = 2$

$$C_{Cor,v}^t(u) = t_{Cor,v}^d \left( t_v^{-1}(u_1), t_v^{-1}(u_2), \dots, t_v^{-1}(u_d) \right),$$

where  $t_v(x) = \int_{-\infty}^{\infty} \Gamma((v+1)/2) / \left( \Gamma(v/2) \sqrt{\pi v} (1+t^2/v)^{(v+1/2)} \right) dt$  denotes the standard univariate Student's t-distribution function with  $v$  degrees of freedom,  $t_v^{-1}(u)$  is its inverse function and  $t_{Cor,v}^d$  joint distribution function of the  $d$ -variate Student's t-distribution with  $v$  degrees of freedom and with matrix  $Cor = (\rho_{ij})$ ,  $i, j = 1, d$  of linear correlation coefficients.

Fig. 4 shows four scatter plots of 1000 random values from a bivariate Student's t-copula for various levels of  $\rho$ . These plots demonstrate that  $t_2$ -copula differs from Gaussian copula, even when their components have the same correlation. The coefficients of lower tail and upper tail dependency are (Aas 2004):

$$\lambda_u(X_1, X_2) = \lambda_L(X_1, X_2) = 2t_{v+1} \left( -\sqrt{v+1} \sqrt{(1-\rho_{12}) / (1+\rho_{12})} \right).$$

Student's t-copula's tail effect from both degrees of freedom and correlation coefficient is as follows: the stronger the linear correlation coefficient and the lower the degrees of freedom, the stronger is tail dependency.

#### 4. The role of Scenario Generator

Scenario Generator (SG) forms the input to the decision simulator and contains stochastic models for a large set of these risk factors, belonging to different groups. The notation of “scenarios” is used to represent how the future might unfold. The main task of SG is to produce adequate scenarios for the uncertain factors. To these uncertain elements usually the theory of probability can be applied. In the paper (Dupačová 1998), the author proposes four types of problems, concerning the level of the available information: (a) full knowledge of underlying probability distribution, (b) known parametric family, (c) sample information, and (d) low



information level. These four groups are not strictly distinguishable. Different information levels can be applied to the distinct parameters of the model. The output of the SG is a large number of random scenarios for the joint behaviour of risk factors included in the model over the given time horizon, representing possible evolution of their future developments.

**4.1. The notation for the scenarios**

The scenarios notation is given based on the references (Dupačová *et al.* 2000; Domenica *et al.* 2007). If a stochastic factor evolves in time, we have a stochastic process. Let introduce the index for time discretization  $t \geq 0$ . The set of all discretization moments is denoted by  $t \in \{0, \dots, T^t\}$ , where  $t = T^t$  is a time horizon,  $t = 0$  is an initial time moment. Time step  $\Delta t$  is the time span from time  $t - 1$  to time  $t$ . Let assume that the stochastic process  $\xi = \{\xi_t\}_{t=1}^{T^t}$  is defined on some filtered probability space  $(\Omega, S, \mathcal{F}, P)$ . The sample spaces  $\Omega$  are taken as finite dimensional. The  $\sigma$ -algebra  $S$  is the set of events with assigned probabilities by measure  $P$ , and  $\{\mathcal{F}_t\}_{t=1}^{T^t}$  is a filtration on  $S$ . For scenario based models, one assumes that the probability distribution  $P$  is discrete, and concentrated on a finite number of points, say,  $\xi^s = (\xi_1^s, \dots, \xi_t^s, \dots, \xi_{T^t}^s)$ ,  $s = 1, \dots, S$ .

If scenarios are described by the expected value of some stochastic factor, the scenarios lose their stochastic nature and scenarios structure is as in a deterministic case.

**4.2. The structure of scenarios**

At the current time moment  $t = 0$ , value  $\xi_0$  is known with certainty. Thus, all scenarios coincide at  $t = 0$ , and the initial root node  $\xi_0$  is formed. Such a structure of simulated data paths is called as scenarios fan (Fig. 5). The probability of  $\xi_t^s$  is denoted as  $\hat{\pi}_t^s = \hat{\pi}_t^s(\xi_t^s)$ ,  $s = 1, \dots, S$ ,  $t \in \{0, \dots, T^t\}$ .

The first stage is usually represented by a single root node, where the values of random parameters are known with certainty. Moving to the second stage, the structure branches into individual scenarios at time  $t = 1$ , as shown in Fig. 5. Such scenarios structure is represented as two-stage problem, as all  $\sigma$ -fields  $\mathcal{F}_t$ ,  $t = 1, \dots, T^t$  coincide. Thus, the probabilities  $\hat{\pi}_t^s = \hat{\pi}_t^s$ ,  $s = 1, \dots, S$ ,  $t \neq t'$ ,  $t, t' > 0$ .

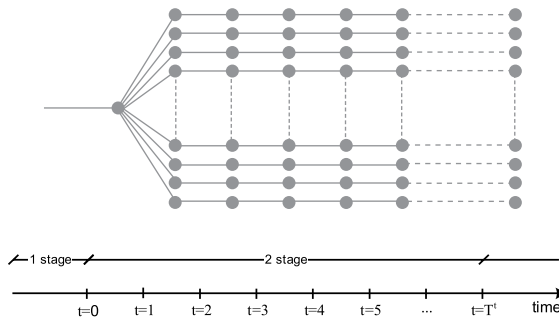

Fig. 5. The illustration of scenarios fan

The other structure of scenarios is a multi-stage scenarios tree, which allows to reflect the inter-stage dependency and decreases the number of nodes while comparing to the scenarios fan. The time stage index  $t \in \{0, \dots, T^t\}$ , where  $\tau = T^\tau$  is a time horizon,  $t = 0$  is an initial decision moment, is associated with time moments when decisions are taken. The stage is the time span  $\Delta\tau$  from time  $\tau - 1$  to time  $\tau$ . The structure of multi-stage scenarios tree (Fig. 6) at  $\tau = 0$  is also described by a sole root node and by branching into a finite number of scenarios as it was in previous case. The probability distribution  $P$  is also concentrated on a finite number of points  $\xi^{S_{T^\tau}} = (\xi_1^{S_1}, \dots, \xi_{s_\tau}^{S_\tau}, \dots, \xi_{T^\tau}^{S_{T^\tau}})$ ,  $s_\tau = 1, \dots, S_\tau$ , but with varying size of scenarios set  $S_\tau$ . The probability of  $\xi_\tau^{S_\tau}$  is denoted as  $\widehat{\pi}_\tau^{S_\tau} = \widehat{\pi}_\tau^{S_\tau}(\xi_\tau^{S_\tau})$ .

The stages are connected with the possibility to take additional decisions based on newly revealed information. Such information can be obtained periodically (every day, week, month) or based on some events (expiration of investment portfolio duration). It is worth to note the tremendous effect of future branching on the size of scenarios tree.

The distinction between stages, which correspond to the decision moments, and time periods of discretization is essential, because in practical application it is important that the number of time periods would be greater than the corresponding nodes, i.e.  $\{0, \dots, T\} \subset \{0, \dots, \widetilde{T}\}$ . The arcs linking nodes represent various realizations of random variables. The number of branches from each node can vary depending on problem specific requirements, and not definitely constant through the tree. One of the strategies is to use an extensive branching at the beginning of time horizon and a relatively poor branching at the last stages of the tree. Each path through the tree from its root to one of its leaves corresponds to one scenario, i.e. to a particular sequence of realizations of random coefficients.

**4.3. The methods for scenario generation**

In general, the procedure of scenario generation consists of the following steps (Domenica *et al.* 2007):

- Choosing an appropriate model to describe the stochastic parameters. For instance, Econometric models and Time Series (Autoregressive models, Moving Average models, Vector Auto Regressive models), Diffusion Processes (Wiener Processes), Calibration of model parameters using historical data.

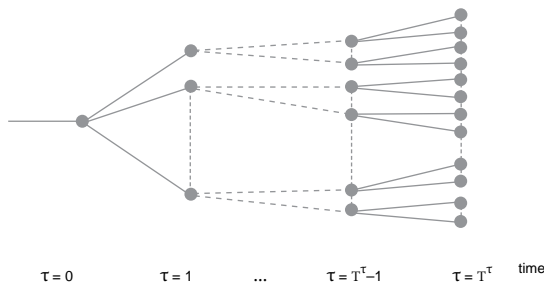

Fig. 6. Multi-stage scenarios tree

- Generation of data paths from the chosen model. Using statistical approximation (Property Matching, Non parametric methods) or sampling (Random sampling, Bootstrapping), the data paths can be generated performing the discretization of the distribution.
- Constructing the scenario tree with the desired properties.

Scenarios can be generated using various methods, based on different principles (Mitra 2006):

- Scenario Generation by Statistical Approaches: Statistical Moment or Property Matching, Principal Components Analysis (PCA), Regression and its variants.
- Scenario Generation by Sampling: Monte Carlo Sampling, Importance Sampling, Bootstrap Sampling, Internal Sampling, Conditional Sampling, Markov Chain Monte Carlo Sampling.
- Scenario Generation by Simulation: Stochastic Process Simulation, Error Correction Model, Vector Auto-regressive.
- Other Scenario Generation Methods: Artificial Neural Networks, Clustering, Scenario Reduction, Hybrid Methods.

A good approximation may involve a very large number of scenarios with probabilities. A better accuracy of uncertainties is described when scenarios are constructed via a simulated data path structure, also known as a scenario fan. But the number of scenarios is limited by the available computing power, together with a complexity of the decision model. To deal with this, we can reduce the dimension of the initial scenario set by constructing the multistage scenario tree out of it.

#### 4.4. The multivariate structure of scenarios employing copulas

In Section 4.3, a common structure for scenario-based risk management, which can be applied to different scenario generation methodologies, is described. But due to the marked progress in the modelling of dependency among stochastic variables, employing copula functions (Section 3), it is important to organize the adequate model of joint variables. In the procedure of scenario generation, the separate step was introduced for a copula-based approach, since copula functions allow to model the dependency structure independently of the marginal distributions.

The basic notation of scenarios was presented in Sections 4.1–4.2. We generalize this notation for  $d$ -dimensional spaces of stochastic factors. For example, these data may correspond to the random return of  $d$  financial assets at different time moments  $t$ . The notation in the multivariate structure will be given for the structure of scenarios fan. Let denote the  $d$ -dimensional probability distribution function of  $\xi_t = (\xi_t^1, \dots, \xi_t^d)$  at point  $y = (y_1, \dots, y_d)'$  by,  $f(y)$  and its  $d$ -dimensional cumulative distribution function by  $F(y)$ . The joint distribution  $F$  provides a complete information concerning the behaviour of  $\xi_t$ .

The marginal probability distribution function and cumulative distribution function of each element  $\xi_t^i$  at point  $y_i$ ,  $i = 1, \dots, d$  is denoted by  $f_i(y_i)$  and  $F_i(y_i)$ , respectively. The primary aim of scenario generator is to represent the distribution  $f$  in a reasonable way. Thus, the underlying probability distribution  $f$  is replaced by a discrete distribution  $P$  car-

ried by a finite number of atoms  $\xi^s = (\xi_1^s, \dots, \xi_t^s, \dots, \xi_{T^t}^s)$ ,  $\xi_t^s = (\xi_t^{s,1}, \dots, \xi_t^{s,d})'$ ,  $s = 1, \dots, S$  with probabilities  $\bar{\pi}_t^s = \bar{\pi}_t^s(\xi_t^s)$ ,  $\sum_{s=1}^S \bar{\pi}_t^s = 1$ ,  $s = 1, \dots, S$ ,  $t \in \{1, \dots, T^t\}$ . The atoms  $\xi^s$ ,  $s = 1, \dots, S$  of the distribution  $P$  are called as scenarios. For each of the considered stochastic factors these scenarios are independently generated. But in the case of multivariate structure of randomness, we introduced the concept of inter-correlated scenarios  $\xi^s = (\xi_1^s, \dots, \xi_t^s, \dots, \xi_{T^t}^s)$ ,  $\xi_t^s = (\xi_t^{s,1}, \dots, \xi_t^{s,d})'$ ,  $s = 1, \dots, S$ ,  $t \in \{1, \dots, T^t\}$ , if the multivariate stochastic distribution  $F$  is constructed employing some dependency structure, like copula functions during the discretization process of underlying randomness.

Using copulas, the distribution  $F$  is given as:

$$F(y_1, y_2, \dots, y_d) = C(F_1(y_1), F_2(y_2), \dots, F_d(y_d)),$$

where  $C$  is the  $d$ -dimensional copula function. For example, it can be Gaussian copula or Student's t-copula, as was introduced in Section 3.3.

## 5. Decision simulator

Decision simulator mimics the company's (or decision maker's) decisions over the planning period. In this work, the case when the insurance company makes decisions regarding their asset mix is considered. The investment planning is carried out under uncertainty because some or all model parameters are not completely known at the current point of time, when decision has to be taken. Despite rich involvement of the future, everything is aimed to make a well hedged decision in the present.

### 5.1. Classification of decision-making problems

Decision-making always involves making a choice between various possible alternatives. According to the considered alternatives, decision problems can be classified into two categories (Murty 2003):

**Category 1.** This category includes all decision problems for which the set of possible alternatives for the decision is a finite discrete set typically consisting of a small number of elements, in which each alternative is fully known in complete details, and any one of them can be selected as the decision. For instance, a person has received job offers from 3 companies. It has to decide whether to accept any one of these offers, or to continue the job search.

**Category 2.** This category includes all decision problems for which each possible alternative for the decision is required to satisfy some restrictions and constraints under which the relevant system must operate. Even when there are no constraints to be satisfied in a decision problem, if the number of possible alternatives is either infinite, or finite but very large, it becomes necessary to define the decision variables in the problem and to construct the objective function (the one to be optimized) as a mathematical function of the decision variables in order to find the optimal alternative to implement.

Decision problems of Category 1 can be solved using the first considered approach – stochastic simulation, where one of the most common techniques used to present the results

is the efficient frontier (Kaufmann *et al.* 2001). This is a technique borrowed from finance theory for constructing the investment portfolio framed in terms of risk and return. “Return” is usually defined as arithmetic mean of key variable, and “Risk” is defined as corresponding standard deviation. Whatever definition of risk and return we wish to apply, we can define an “efficient” set of decisions (strategies). A decision is called efficient if there is no other one with a lower risk at the same level of return, or higher return at the same level of risk. For each level of risk there is a maximal return that cannot be exceeded, giving a rise to an efficient frontier. But we cannot be sure that a decision is really efficient or not. Stochastic simulation is not necessarily a method to come up with an optimal strategy. It is predominantly a tool to compare different decisions. It is important to note that a different measure of risk and return may lead to a different preferred decision.

Optimal decisions can be found when decision problems are formulated according to the concept of Category 2, as it is the main concept of the stochastic programming approach (Yu *et al.* 2003; Ziemba 2003; Kouwenberg and Zenios 2006; Dempster *et al.* 2003). This technique is known as strategy generation approach. On the conceptual level, stochastic programming combines two main components:

- Model of optimum resource allocation. It constitutes the core of the problem that has to be solved and varies with respect to the specific characteristics of each individual application.
- Model of uncertainty. Once the distribution is established, different scenarios that follow the underlying probability distribution are used to represent the randomness.

Thus, both strategy evaluation model and strategy generation model are based on the output from the Scenario Generator, but the structure of scenarios set is set to be different. For the stochastic optimization, when the strategy is generated, the multidimensional multistage scenario tree is preferable cause of limited available computing power. For the stochastic simulation when the set of strategies are evaluated, the scenarios fan is used. It is because the set of alternative strategies enlarges over the structure of scenarios tree and it is the very time consuming to evaluate all strategies for the initial and rebalancing time moments.

## 5.2. Notation for decisions

Let define that  $n$ -dimensional vector  $x$  represents values that are under control of the insurance company management. Note that the spaces, from which the decisions are to be chosen, are taken as finite-dimensional but of possible varying dimensionality. If the structure of scenarios fan is used to describe the uncertainty, the initial decision  $x - x_0$  taken at the current time moment can only be considered. It is because of the requirements of decision-making models under uncertainty explained in the paper (Dupačová *et al.* 2000). The multi-stage decision-making model must avoid looking into the future in an inappropriate fashion. To prevent this occurrence, the special constraints are added to the model, called non-anticipatory conditions, i.e. the decision taken at any time does not directly depend on future realizations of stochastic parameters or on future decisions.

If the structure of multi-stage scenarios tree is used for describing the randomness, the decisions are of two types: the initial decision  $x_0$  taken at the current moment (anticipation) and the recourse decisions  $x_\tau$ ,  $\tau > 0$  taken at  $\tau \in \{1, \dots, T^\tau\}$  recourse stages (adapta-

tion). Thus, the decision at stage  $\tau > 0$  is the random variable  $x_\tau : \Omega \rightarrow R^n$ ; decisions are set as  $n$ -dimensional, but in general, may be of possibly varying dimensionality. In the stochastic programming model, the observations and decisions are given as a sequence  $x_0, (\xi_1, x_1), (\xi_2, x_2), \dots, (\xi_{T-\tau}, x_{T-\tau})$ , where  $x = \{x_\tau\}_{\tau=0}^{T-\tau}$  is a decision process, measurable function of  $\xi = \{\xi_\tau\}_{\tau=1}^{T-\tau}$ . The constraints on a decision at each stage involve past observations and decisions. It means that decision  $x_\tau$  at  $\tau$  is measurable with respect to  $\mathcal{F}_\tau \subseteq \mathcal{F}$ . Thus, the decision process is said to be non-anticipative based on the notion described in the paper (Dupačová *et al.* 2000), i.e. the decision  $x_\tau = x_\tau(x_{\tau-1}, \xi_{\tau-1})$  taken at any  $\tau > 0$  does not directly depend on future realizations of stochastic parameters or on future decisions. At the time when initial decision  $x_0$  must be chosen, nothing about the random elements in our process has been pinpointed. But in making a recourse  $x_\tau$  decision in stage  $\tau$  we have the revealed current information  $(\xi_1, \dots, \xi_\tau)$  until this moment and the residual uncertainty  $(\xi_{\tau+1}, \dots, \xi_{T-\tau})$  till the end of time horizon. The distribution for  $(\xi_{\tau+1}, \dots, \xi_{T-\tau})$  is its conditional probability distribution given  $(\xi_1, \dots, \xi_\tau)$ . By a strategy of insurance company, we will mean a choice of the initial decision  $x_0$  together with a choice of recourse functions  $(x_1, \dots, x_{T-\tau})$ . Decisions that are taken have no effect on the probability structure. Thus, we have a multi-stage decision-making formulation. The set  $x$  of these control values is called strategy.

## 6. The model of decision-making in insurance business

### 6.1. The conceptual model

The decisions of investment and underwriting activity of insurance company concern the asset liability management. Thus, the framework given in Fig. 1 can be applied. The asset management is associated with investment activity, and the liability management is associated with underwriting activity. The revenues from the performance of investment and underwriting business are added to the insurer's asset, while the wealth is depleted by outflows allocated to various investments and by claims of its clients. The main goal of a modelled company is to earn the profit and to cover claims carried by its clients.

**Table 1.** Risk factors and decision variables of investment activity

Risk factors of investment business
Inflation rate $q_{1t}$ and its expectations $R_{t,T}^q$
Real interest rate $r_{1t}$ and its term structure $R_{t,T}^r$
Return on cash $R_{t-\Delta t,t}^{nom}$
Yield of discount bonds $R_{t,T}^{nom}$ with maturity $T$
Return on stocks $E_t$
Decisions of investment performance
Weights $(\alpha_1, \dots, \alpha_J)$ of asset allocation to $J$ investments

**Table 2.** Risk factors and decision variables of underwriting activity

<b>Risk factors of underwriting business</b>	
Number of non-catastrophe losses	$N_t^{noncat}$
Severity of non-catastrophe losses	$X_t^{noncat}$
Number of catastrophes	$N_t^{cat}$
Severity of catastrophe losses	$X_t^{cat}$
Exposure units	$w_t$
Underwriting cycles	$\Pi$
Expenses	$G_t$
<b>Decisions of underwriting performance</b>	
Safety loading $\theta$ in determining the size of premiums	$B_t$

The cash flows of both investment activity and underwriting activity are influenced by risk factors, which are classified in Tables 1–2.

The set of scenarios is simulated to represent the behaviour of each stochastic risk factor. Strategy is evaluated or generated to represent the decisions of a modelled insurance company

The main feature of risky variables is that they are uncontrollable, i.e. the insurance company can not affect their values. The set of scenarios having the structure of scenarios fan is created to represent the behaviour of stochastic risk factors in the future. The index  $t \geq 0$  for time discretization is introduced in order to construct the scenarios fan. The set of all discretization moments is denoted by  $t \in \{0, \dots, T^t\}$ , where  $t = T^t$  is a time horizon,  $t = 0$  is an initial time moment. Simulation time step  $\Delta t$  is the time span from time  $t - 1$  to time  $t$ .

The scenarios fan can be approximated by multi-dimensional multi-stage scenarios tree employing some clustering approach, introducing additional stages  $\tau \geq 0$  for determined decision moments in advance. Thus, stages are connected with decision moments. The set of all decision moments is denoted by  $\tau \in \{0, \dots, T^\tau\}$ , where  $\tau = T^\tau$  is a time horizon,  $\tau = 0$  is an initial decision moment. The stage is the time span  $\Delta \tau$  from time  $\tau - 1$  to time  $\tau$ . Since the investment strategy is considered in this paper, the scenario tree has to be constructed only for asset returns.

The models of risky variables concerning the investment activity are based on the reference (Hibbert *et al.* 2001); the models concerning the underwriting activity are based on the reference (Kaufmann *et al.* 2001). The short description of these variables is given below.

*Inflation rate  $q_{1t}$  and its expectations  $R_{t,T}^q$*  are stochastic variables used to represent the possible behaviour of short-term inflation rate and inflation expectations over different time horizons  $T$ . The scenarios fan is created by discretization procedure of two factors Ornstein-Uhlenbeck process in continuous time and its Monte Carlo simulation. Values of these stochastic variables are simulated over all planning horizon with simulation step  $\Delta t$ . Inflation rate correlates with real interest rate  $r_{1t}$  through the dependency structure – Gaussian copula or Student's copula (Section 3.3). Inflation rate has impact on the severity of

company's non-catastrophe and catastrophe losses, as well as on premiums size. This relation is modelled introducing the variable  $\tilde{q}_t^X$ , which describes inflation's impact on loss severity, and variable  $\tilde{q}_t^{X \cdot c}$ , which describes the cumulative change in loss severity triggered by changes in inflation rates.

*Real interest rate*  $r_{1t}$  and its term structure  $R_{1,T}^r$  are the stochastic variables used to represent the possible behaviour of short term real interest rate and the yield of real discount bonds with maturity  $T$ . The scenarios fan is created by discretization procedure of two factors Ornstein-Uhlenbeck process in continuous time and its Monte Carlo simulation. The values of these stochastic variables are simulated over all planning horizon with simulation step  $\Delta t$ . Real interest rate  $r_{1t}$  correlates with inflation rate  $q_{1t}$  through the dependency structure – Gaussian copula or Student's copula (Section 3.3).

*Return on cash*  $R_{1-\Delta t,t}^{nom}$  is a stochastic variable, obtained by combining the short-term inflation rate  $q_{1t}$  and short-term real interest rate  $r_{1t}$ . The scenarios fan with simulation step  $\Delta t$  is created by summing up the corresponding values from the scenarios fan for inflation rate and for real interest rate. The multi-stage scenarios tree with stages  $\tau$  for return on cash  $R_{1t}$  is constructed to approximate the scenarios fan of  $R_{1-\Delta t,t}^{nom}$ , employing the clustering procedure described in the reference (Pranevičius and Sutienė 2007).

*Yield of discount bonds*  $R_{t,T}^{nom}$  is a stochastic variable used to describe the return of nominal discount bonds for defined discretization time moments  $t$  with time maturity  $T$ . The scenarios fan of yields for nominal discount bonds for each time maturity  $T$  is obtained by summing up the corresponding values from the scenarios fan of inflation expectations  $R_{t,T}^q$  and from the scenarios fan of the term structure for real interest rate  $R_{t,T}^r$ . The multi-stage scenarios tree with stages  $\tau$  for return on bonds portfolio  $R_{2\tau}$  is constructed to aggregate and to approximate the scenarios fans of  $R_{t,T}^{nom}$  with time maturity  $T$ , employing the clustering procedure described in the reference (Pranevičius and Sutienė 2007).

*Return on stocks*  $E_t$  is a stochastic variable used to generate the total return from stocks, using two regime Markov chain model. The scenarios fan is constructed for defined time discretization moments  $t$ . The multi-stage scenarios tree with stages  $\tau$  for return on stocks  $R_{3\tau}$  is constructed to approximate the scenarios fan of  $E_t$ , employing the clustering procedure described in the reference (Pranevičius and Sutienė 2007).

*Number of non-cat losses*  $N_t^{noncat}$  and *mean severity of non-catastrophe losses*  $X_t^{noncat}$  are stochastic variables used to describe the total non-catastrophe losses for defined time discretization moments. These losses depend on the written exposure units  $w_t$ . The scenarios fan of number of non-catastrophe losses is created by sampling procedure from Negative Binomial distribution; the scenarios fan of mean loss severity is sampled from Gamma distribution. The loss severity is influenced by the size of inflation rate.

*Catastrophes*  $N_t^{cat}$  can occur accidentally, which generate the catastrophe losses, modelled by the *severity of catastrophe losses*  $X_t^{cat}$ . Since their values are stochastic, the scenarios fan is created by sampling procedure: the number of catastrophes  $N_t^{cat}$  is sampled from Poisson distribution, and the severity of catastrophes  $X_t^{cat}$  is sampled from Lognormal distribution.

*Exposure unit*  $w_t$  is a stochastic variable used to describe the number of persons or properties exposed to insurance losses. To simulate its values with simulation step  $\Delta t$ , the autoregressive process of order 1 is assumed. The scenarios fan is created by simulation



procedure. Exposure units influence the values of number of non-catastrophe losses, the values of expenses and the values of written premiums.

*Underwriting cycles*  $\Pi$  are stochastic variables, simulated from the homogeneous Markov chain model and used to describe the states of competition between the insurance companies. Thus, in every underwriting cycle the size of written premiums is modified by introducing the coefficients depending on the state of underwriting cycle. The scenarios fan is created to represent the transition probabilities at each simulation step  $\Delta t$ .

*Expenses*  $G_t$  are stochastic variables and depend on the written exposure units  $w_t$ . The deterministic relation is used to model the dependency from exposure units.

*Written premiums*  $B_t$  are separated from the earned premiums  $B_t^{earn}$ . The separation of these premiums is done because not all premiums are collected at once for time  $t$ , some of them can be received after the time  $t$ . Written premiums  $B_t$  are influenced by the change in loss trends  $\tilde{q}_t^X$ , by the position in the underwriting cycle  $\Pi$ , and by the number of written exposures  $w_t$ .

For the risky variables of real interest rate and inflation rate, the dependency structure using functions of Gaussian copula and Student's t-copula are employed: short-term real interest rate  $r_{1t}$  correlates with short-term inflation rate  $q_{1t}$ , and long-term real interest rate  $r_{2t}$  correlates with long-term inflation rate  $q_{2t}$ . Contemporaneous dependencies among these variables are identified through Wiener processes  $dZ_i(t) \sim N(g_i dt, dt)$ ,  $i = \overline{1, 4}$ . To model the dependency between these stochastic drivers, we construct the joint distribution  $F_t$  by linking these marginal distributions through the copula function:

$$F_t(y_1, y_2, y_3, y_4) = C\left(\Phi\left(\frac{y_1 - g_1 t}{\sqrt{t}}\right), \Phi\left(\frac{y_2 - g_2 t}{\sqrt{t}}\right), \Phi\left(\frac{y_3 - g_3 t}{\sqrt{t}}\right), \Phi\left(\frac{y_4 - g_4 t}{\sqrt{t}}\right)\right),$$

where  $C$  is the 4-dimensional copula function – Gaussian or Student's  $t_v$  dependency structure (Section 3.3). In a discrete form, let Wiener processes  $dZ_i(t)$  be represented by  $\varepsilon_{it}$ ,  $i = \overline{1, 4}$ :

$$\varepsilon_{it} \sim (g_i \Delta t + \varepsilon_i \sqrt{\Delta t}), \quad \varepsilon_i \sim N(0, 1).$$

Thus, the dependency structure can be described with the joint distribution  $F_t$  by linking the marginal distributions  $\varepsilon_i \sim N(0, 1)$ ,  $i = \overline{1, 4}$  through the copula function. We get

$$F_t(y_1, y_2, y_3, y_4) = C(\Phi(y_1), \Phi(y_2), \Phi(y_3), \Phi(y_4)),$$

where  $C$  is the 4-dimensional copula function (Section 3.3). The simulation algorithm of this equation with incorporated Gaussian copula or Student's  $t_2$  copula is given in the reference (Pranevičius and Štutienė 2006).

Making adequate decisions, the modelled company can hedge the risk of these uncertainties. In this case of a study, the decisions are evaluated for the underwriting and investment business jointly. The value of safety loading  $\theta = 0,2$  is fixed, and the decisions concerning the investment activity are explored.

Weights  $(\alpha_1, \dots, \alpha_J)$  of asset allocation to various investments  $J$  are modelled as decision variables and used to represent the different asset mixes by different combinations of the weights applied to the investment portfolio. The free reserves, resulted from the underwriting activity plus the initial surplus  $D_0$ , are allocated among a few aggregated asset classes, such as cash, bonds and stocks. It is we assumed that the investments in these asset classes are bounded with lower limit and upper limit as follows:  $\alpha_1 = (0, 0.2)$  for cash,  $\alpha_2 = (0, 4, 0, 9)$  for bonds, and  $\alpha_3 = (0, 3, 0, 6)$  for stocks. These constraints are introduced in the model, because such requirements are usually under statutory restriction. The base strategy is chosen as the fraction  $(0, 0, 4, 0, 6)$  to cash, bonds and stocks from the invested wealth. Since the set of alternatives decisions can be enough big, especially if more asset classes are considered, two approaches are applied for choosing the weights of asset allocation:

The *best strategy* is found at the initial time moment  $t = 0$ , applying the stochastic simulation approach described in Section 5. The set of alternative strategies is evaluated over the set of simulated scenarios having the structure of scenarios fan.

The *optimal strategy* for the weights of asset allocation at the initial time moment  $\tau = 0$  and the *recourse strategies* for the weights of asset allocation to various investments at recourse stages  $\tau > 0$  investments are found, applying the stochastic programming (optimization) approach. The decisions at recourse stages are considered as rebalancing decisions, anticipated at the initial time moment. The objective function and constraints, both incorporating stochastic variables, are formulated. The multi-stage multi-dimensional scenario tree with nodes containing information about returns on cash  $R_{1\tau}$ , bonds  $R_{2\tau}$ , and stocks  $R_{3\tau}$  is used in decision generating.

## 6.2. The formal model

The described decision-making model is specified by formal method Piece Linear Aggregates (PLA) (Pranevičius 2004). The activity of the modelled company is formalized by introducing the following aggregates:

- Aggregate “RF” is used to specify the certain risk factor, arising from the insurance company’s environment. Since there exist several types of risk factors, the aggregates are classified into 2 groups:
  - The first group “ASG” represents Asset Scenario Generator (ASG) and combines the aggregates used to specify the behaviour of stochastic risk factors that influence the company’s cash flows of investment activity. Some of these risk factors have a link with risk factors from “LSG” group.
  - The second group “LSG” represents Liability Scenario Generator (LSG) and combines the aggregates used to specify the behaviour of stochastic risk factors that influence the company’s cash flows of underwriting activity.
- Aggregate “DS” is used to specify the dependency structure among correlated stochastic variables in a multivariate structure incorporating copula function.
- Aggregate “UA” is used to specify the underwriting activity itself. The decisions concerning the underwriting activity are determined. In this case of a study, the safety loading  $\theta$  is fixed.

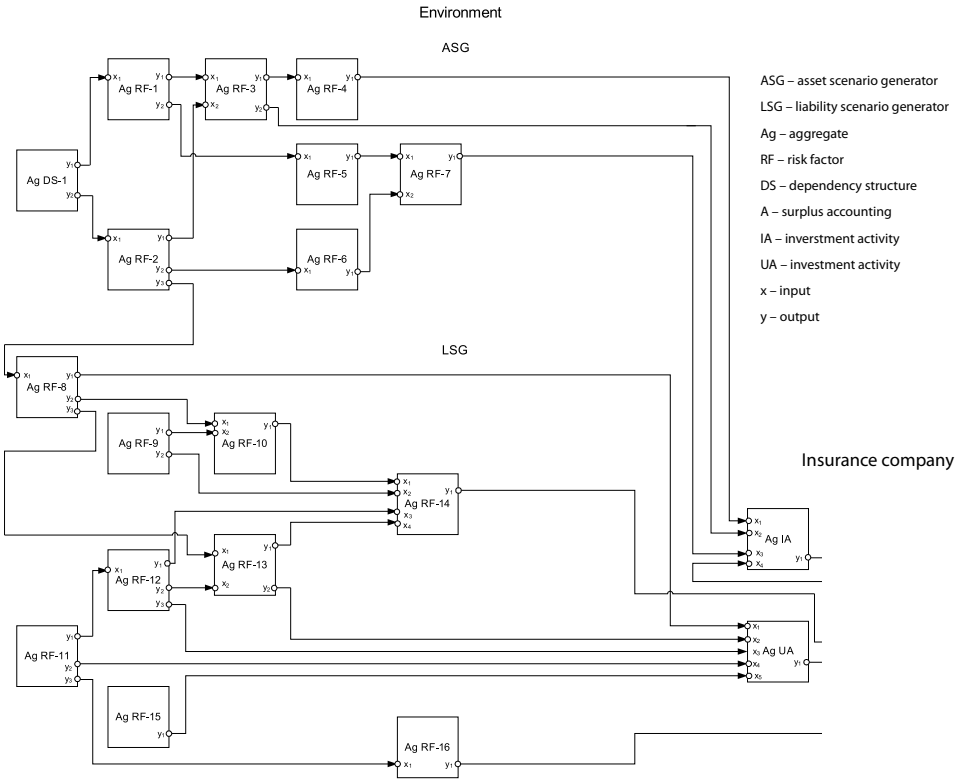

Fig. 7. Aggregate scheme for the decision-making model in insurance business

- Aggregate “IA” is used to specify the investment activity itself. The decisions concerning the weights  $(\alpha_1, \dots, \alpha_J)$  of asset allocation to various investments  $J$  are explicitly considered.
- Aggregate “A” is used to specify the accounting of insurance company’s cash flows based on the equation:

$$\Delta D_t = \Delta I_t + B_t^{earn} - Z_t^{ult} - G_t,$$

where  $D_t$  is the surplus of an insurance company,  $B_t^{earn}$  is a value of earned premiums,  $Z_t^{ult}$  is a value of ultimate losses of modelled insurance company,  $G_t$  is a value of general expenses of modelled insurance company,  $\Delta I_t$  is an income from assets’ investment.

The development of written premiums  $B_t$  and computation of earned premiums  $B_t^{earn}$  are given in reference (Kaufmann *et al.* 2001). Based on this reference, it is still needed to employ some principles for premiums determining at the current time. That’s why referring to the premiums principles (Landsmana and Sherrisb 2001), we set the initial premiums  $B_0$  as

$$B_0 = w_0 (1 + \theta) N_0^{noncat} X_0^{noncat},$$

where  $w_0$  – written exposure units at the initial time moment  $t = 0$ ,  $N_0^{noncat}$  – the number of non-catastrophe losses at the initial time moment  $t = 0$ ,  $X_0^{noncat}$  – the mean severity of non-catastrophe losses at the initial time moment  $t = 0$ ,  $\theta \in (0, 1]$  – the safety loading.

The structural scheme of related system is depicted in Fig. 7. It is the base structure which is used in developing the decision-making model for a modelled insurance company.

### 7. The numerical experiment

We will compare the results obtained from stochastic simulation and stochastic optimization approaches in the context of a specific investment portfolio problem of insurance company. The portfolio selection problem is modelled at the strategic level, where resources are allocated among a few aggregated asset classes, such as cash, stock and bonds. The objective is to maximize the expected portfolio value at the end of the horizon net of costs, subject to some constraints.

In the experiment, we will have 4 cases at all (Table 3). The copula functions are used to describe the dependency structure among real interest rate and inflation rate. Two cases are separated for the instances when catastrophes losses are ignored and when they have a low probability to occur.

**Table 3.** The considered cases for the experiment

Instances of the considered experiment	Gaussian copula	Student's $t_2$ copula
Catastrophe event is ignored	YES	YES
Catastrophe event is not ignored	YES	YES

The common settings for both decision-making approaches are as follows. Scenarios fan for each of the stochastic element consists of 1000 scenarios, which are generated with 1-month step during 10 years time horizon. The initial investment consists of the current surplus from

underwriting business plus the initial surplus  $D_0 = 5 \cdot 10^4$ . As it was described in Section 6.1, the lower bound for bonds is usually statutory restrictions; thus, stocks and cash investments are chosen so that the total weights in the remaining portfolio sum up to 100 %. The transaction costs for purchasing and selling the assets are ignored.

#### 7.1. The scheme for insurance company management

The implemented scheme, which is constructed based on the Fig. 1 and Fig. 7, for strategy evaluation and strategy generation is depicted in Fig. 8. The best or optimal decisions are associated with Asset Liability Management (ALM) in a modelled insurance company.

From Fig. 8, strategy evaluation is based on scenarios fan for each stochastic risk factor concerning the investment and underwriting activities. Strategy generation is based on scenarios fan for each stochastic risk factor concerning the underwriting activity and scenarios tree for stochastic risk factors concerning the investment activity.

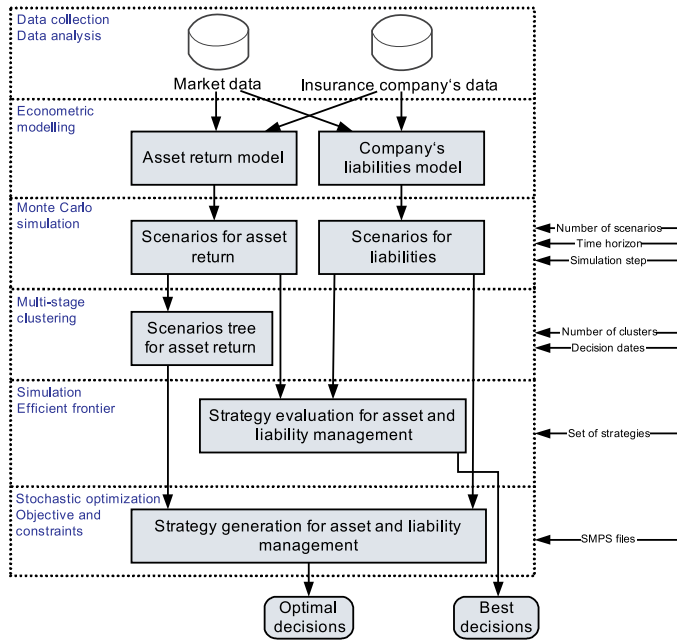

Fig. 8. Structural scheme of insurance company management

7.2. Strategy evaluation for the investment business

For the strategy evaluation, we will explore how different levels of asset returns affect the insurance company’s surplus. We vary the scenarios and fix the concrete values of portfolio weights at the current time moment  $t = 0$ . As depicted in Fig. 8, for the strategy evaluation (if stochastic simulation is applied), the scenarios fans for the classes of assets and liabilities have to be generated. The alternative strategies (Table 4) are tested over the equation, which describes the cash flows of a modelled insurance company (Section 6.1). The simulation is performed for each strategy separately. Then, the surplus is evaluated at the end of time horizon, and the efficient frontier of decisions is constructed.

For the output analysis and strategy evaluation we use the measures:

- Surplus reward as the mean value of scenarios for estimated surplus at the end of time horizon.

Table 4. The set of alternatives strategies

Case No.	Asset mix (cash, bonds, stocks), %
1	(0, 40, 60)
2	(0, 70, 30)
3	(10, 40, 50)
4	(10,60,30)
5	(20, 50, 30)

- The mean value of the total duration  $TT$  of negative surpluses over all planning horizon.

The obtained results are analyzed through the efficient frontier concept (Figs 9–12).

From Figs. 9–12, one can see that strategies 2, 5 and partially 5 form the efficient frontier in all cases.

For the case, when the catastrophe event is ignored (Figs 9–10), it can be seen that under Student's  $t_2$  dependency structure the surplus reward is lesser and the risk is higher compared with the Gaussian dependency structure. Choosing the strategy with minimal risk, the Case 2 with investment portfolio composition (0, 70, 30) in cash, bonds, and stocks is recommended independently from Gaussian or Student's  $t_2$  dependency structure.

For the case, when the catastrophe event is not ignored (Figs 11–12), it can be seen that under Student's  $t_2$  dependency structure, the reward is higher, but the risk is lower comparing it with the reward and risk under Gaussian dependency structure. For choosing the strategy with minimal risk, the Case 2 with investment portfolio composition (0, 70, 30) in cash, bonds, and stocks is recommended independently of Gaussian or Student's  $t_2$  dependency structure is employed.

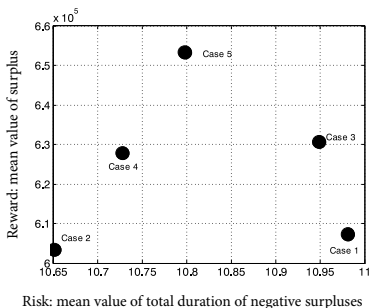

**Fig. 9.** The efficient frontier under Gaussian copula without catastrophe event

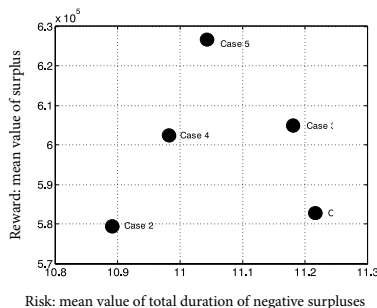

**Fig. 10.** The efficient frontier under Student's  $t_2$  copula without catastrophe event

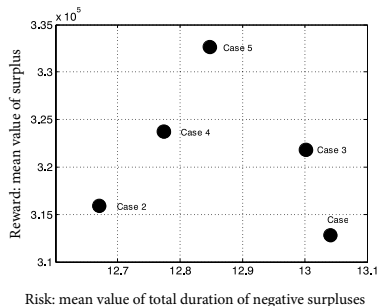

**Fig. 11.** The efficient frontier under Gaussian copula with catastrophe event

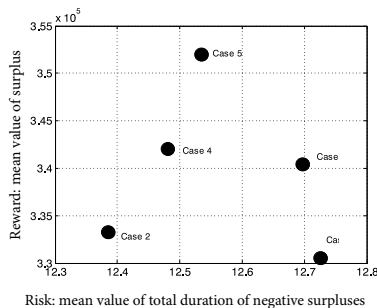

**Fig. 12.** The efficient frontier under Student's  $t_2$  with catastrophe event

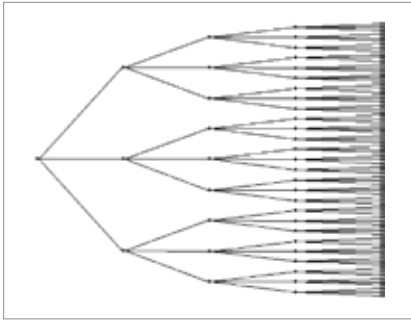

Fig. 13. 5-stage scenarios tree of stochastic parameters

### 7.3. Strategy generation for the investment business

For the strategy generation, where the rebalancing of decisions is possible, the planning horizon is decomposed into stages. The first stage is the initial time moment  $\tau = 0$ , and the recourse stages are  $t = (1, 3, 6, 10)$  in years. It determines that we have 5 stages during 10 years time horizon. The scenario tree with 5 stages (Fig. 13) and with 3 scenarios per each node is generated. It is used as an input for a considered problem. The target value of surplus determined at the end of 10 years is needed for the optimization task and is set equal to  $4 \cdot 10^5$ .

The following formulation is fairly standard in Asset Liability Management applications of stochastic optimization.

*Inventory constraints* are used to describe the dynamics of holdings in each asset class:

$$h_{\tau,j}^s = R_{\tau,j}^s h_{\tau-1,j}^s + p_{\tau,j}^s - q_{\tau,j}^s,$$

where  $\tau \in \{0, \dots, T^\tau\}$ ,  $s = 1, \dots, S$ ,  $j = 1, \dots, J$ ,  $R_{\tau,j}^s$  – return on asset  $j$  (random) over period  $[\tau-1, \tau]$  in scenario  $s$  are parameters; and  $p_{\tau,j}^s$  – non-negative purchases of asset  $j$  at time  $\tau$  in scenario  $s$ ,  $q_{\tau,j}^s$  – non-negative sales of asset  $j$  at time  $\tau$  in scenario  $s$ ,  $h_{\tau,j}^s$  – holdings in asset  $j$  in period  $[\tau, \tau+1]$  are decision variables. For the initial time moment  $\tau = 0$ , the equation of inventory constrains is:

$$h_{0,j}^s = h_j^0 + p_{0,j}^s - q_{0,j}^s,$$

where  $h_j^0$  – initial holdings in asset  $j$ ,  $j = 1, \dots, J$ ,  $s = 1, \dots, S$ .

*Budget constraints* are used to guarantee that the total expenses do not exceed revenues:

$$\sum_{j \in J} (1 + k_j^p) p_{\tau,j}^s \leq \sum_{j \in J} (1 - k_j^q) q_{\tau,j}^s + V_\tau - L_\tau,$$

where  $\tau \in \{0, \dots, T^\tau\}$ ,  $s = 1, \dots, S$ ,  $j = 1, \dots, J$ ,  $k_j^p \geq 0$  – transaction costs for buying asset  $j$ ,  $k_j^q \geq 0$  – transaction costs for selling asset  $j$ ,  $V_\tau$  – cash inflows of underwriting business (random) in period  $[\tau-1, \tau]$ ,  $L_\tau$  – cash outflows of underwriting business (random) in period  $[\tau-1, \tau]$  are parameters.

*Portfolio constraints* give limits for the allowed range of portfolio weights:

$$\underline{b}_j \sum_{j \in J} h_{\tau,j}^s \leq h_{\tau,j}^s \leq \bar{b}_j \sum_{j \in J} h_{\tau,j}^s,$$

where  $\tau \in \{0, \dots, T^\tau\}$ ,  $s = 1, \dots, S$ ,  $j = 1, \dots, J$ ,  $\sum_{j \in J} h_{\tau,j}^s$  – total wealth at time  $\tau$ ,  $\underline{b}_j$  – lower bound for the proportion of  $\sum_{j \in J} h_{\tau,j}^s$  in asset  $j$ ,  $\bar{b}_j$  – upper bound for the proportion of  $\sum_{j \in J} h_{\tau,j}^s$  in asset  $j$  are parameters.

Of course, the income should be sufficient to cover the liabilities and to earn the gain. To encourage such outcomes, let  $\psi_\tau$  be the target wealth at the horizon  $\tau = T^\tau$ ,  $\bar{w}_T^s$  be an excess over target wealth at horizon  $\tau = T^\tau$ ,  $\bar{w}_T^s$  be a deficit under target wealth at horizon  $\tau = T^\tau$ . The objective function will include  $d_1$ , the penalty coefficient for the shortfall, and  $d_2$ , the reward coefficient for the surplus. Thus, the *required wealth constraint* is:

$$\sum_{j \in J} R_{T^\tau, j}^s h_{T^\tau-1j}^s + V_{T^\tau} - L_{T^\tau} - \bar{w}_{T^\tau}^s + \underline{w}_{T^\tau}^s = \psi_{T^\tau},$$

and the *objective function*:

$$\min \sum_{s=1}^{S_{T^\tau}} \hat{\pi}_s \left[ d_1 \cdot \underline{w}_{T^\tau}^s - d_2 \cdot \bar{w}_{T^\tau}^s \right],$$

where  $\hat{\pi}_s$  – probability of scenario  $s$ .

Given optimization problem is a multi-stage stochastic program with recourse. The flows for the optimization model are generated from Scenario Generator. Random parameters  $R_{t,j}^s$  are described by the scenario tree (Fig. 13), whose nodes are 3-dimensional vectors. It was solved using SLP\_IOR solver (Kall and Mayer 2007), developed by P. Kall and J. Mayer (University of Zurich, Switzerland). The given problem is imported to the solver in SMPS standard (Gassmann and Kristjansson 2007). It is the extension of well-known MPS format for deterministic optimization programs.

The given optimization task is reformulated in matrix notation. To do this, order the number of possible asset classes for an allocating resources in any way, and let  $J$  be the number of assets. Define vectors:

$$H_\tau = \begin{bmatrix} h_{\tau,1} \\ \vdots \\ h_{\tau,J} \end{bmatrix}, \tilde{H}_0 = \begin{bmatrix} h_1^0 \\ \vdots \\ h_J^0 \end{bmatrix}, P_\tau = \begin{bmatrix} P_{\tau,1} \\ \vdots \\ P_{\tau,J} \end{bmatrix}, Q_\tau = \begin{bmatrix} q_{\tau,1} \\ \vdots \\ q_{\tau,J} \end{bmatrix},$$

$$\tilde{R}_\tau = \begin{bmatrix} R_{\tau,1} \\ \vdots \\ R_{\tau,J} \end{bmatrix}, K^p = \begin{bmatrix} 1+k_1^p \\ \vdots \\ 1+k_J^p \end{bmatrix}, K^q = \begin{bmatrix} 1-k_1^q \\ \vdots \\ 1-k_J^q \end{bmatrix},$$

$$x_\tau = \left[ H_\tau \quad P_\tau \quad Q_\tau \quad \bar{w}_\tau \quad \underline{w}_\tau \right]',$$

$$\bar{B} = \text{diag}(\bar{b}_1, \dots, \bar{b}_J), \underline{B} = \text{diag}(b_1, \dots, b_J), \tilde{I} = 1_{J \times J}.$$

Then, we may express the given problem in a matrix notation. For  $\tau \in \{0, \dots, T^\tau\}$ , define

$$A_\tau = \begin{bmatrix} I_{J \times J} & -I_{J \times J} & I_{J \times J} & 0_{J \times 1} & 0_{J \times 1} \\ 0_{1 \times J} & (K^p)^\top & -(K^q)^\top & 0 & 0 \\ I_{J \times J} - \bar{B}\tilde{I} & 0_{J \times J} & 0_{J \times J} & 0_{J \times 1} & 0_{J \times 1} \\ \bar{B}\tilde{I} - I_{J \times J} & 0_{J \times J} & 0_{J \times J} & 0_{J \times 1} & 0_{J \times 1} \\ 0_{1 \times J} & 0_{1 \times J} & 0_{1 \times J} & -\delta_{\tau T^\tau} & \delta_{\tau T^\tau} \end{bmatrix},$$



$$W_\tau = \begin{bmatrix} -I_{J \times J} \tilde{R}_\tau (1 - \kappa_\tau) & 0_{J \times J} & 0_{J \times J} & 0_{J \times 1} & 0_{J \times 1} \\ 0_{1 \times J} & 0_{1 \times J} & 0_{1 \times J} & 0 & 0 \\ 0_{J \times J} & 0_{J \times J} & 0_{J \times J} & 0_{J \times 1} & 0_{J \times 1} \\ 0_{J \times J} & 0_{J \times J} & 0_{J \times J} & 0_{J \times 1} & 0_{J \times 1} \\ \delta_{\tau T^\tau} (\tilde{R}_\tau)' & 0_{1 \times J} & 0_{1 \times J} & 0 & 0 \end{bmatrix},$$

$$b_\tau = \begin{bmatrix} \kappa_\tau \tilde{H}_0 \\ V_\tau - L_\tau \\ 0_{J \times 1} \\ 0_{J \times 1} \\ \delta_{\tau T^\tau} (\Psi_\tau - V_\tau + L_\tau) \end{bmatrix}, \quad \delta_{\tau T^\tau} = \begin{cases} 1, & \text{if } \tau = T^\tau, \\ 0, & \text{otherwise.} \end{cases}$$

$$\kappa_\tau = \begin{cases} 1, & \text{if } \tau = 0, \\ 0, & \text{otherwise.} \end{cases}$$

$$c_\tau = \begin{bmatrix} 0_{1 \times J} & 0_{1 \times J} & 0_{1 \times J} & -d_2 \delta_{\tau T^\tau} & d_1 \delta_{\tau T^\tau} \end{bmatrix}.$$

In the first stage, the initial decision  $x_0$  has to be chosen from the set  $\{x_0 \in R^{3J+2} : A_0 x_0 \infty b_0\}$  at a direct cost  $c_0 x_0$ . The notation  $\infty$  denotes the equality or inequality respectively. Depending on the decision  $x_0$  taken at present and the realizations  $\{\xi_\tau\}_{\tau=1}^{T^\tau}$  that would be available in the future, there would be the indirect costs due to the recourse actions. If the realization  $\xi_1$  is observed, then the recourse decision  $x_1$  is chosen from the set  $\{x_1 \in R^{3J+2} : A_1 x_1 \infty b_1 - W_1(\xi_1) x_0\}$  at a direct cost  $c_1 x_1$ . Such logic of finding decisions is applied to all stages until the end of time horizon is reached.

According to the settings for a numerical experiment, the non-zero pattern of constraints is depicted in Fig. 14. The obtained results the optimal value of objective function for 4 experiment's cases (Table 3) are analyzed through Tables 5–6, distinguished for the cases, when the catastrophe event occurs or not. The negative value of objective function means that we get the excess over the target capital, i.e. the rebalancing in recourse stages enlarges the insurance company's surplus. The portfolio compositions for 4 considered cases are also given in Tables 5–6.

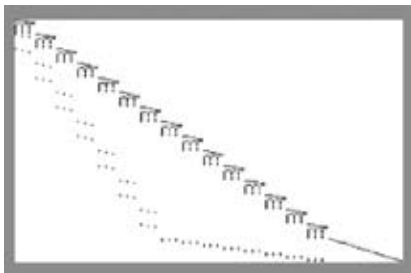

Fig. 14. The non-zero pattern of constraints

For all cases the recommended decisions for the optimal composition of investment portfolio in cash, bonds, and stocks respectively is the same. We get the excess over the target capital, i.e. the rebalancing in recourse stages enlarges the insurance company's surplus. But the obtained surplus at the end of planning horizon is different for the considered 4 cases.

**Table 5.** The optimal values under different dependency structures without catastrophe event

	Gaussian dependency	Student's $t_2$ -dependency
Stochastic value of objective function, $\cdot 10^5$	-7,6041	-7,7565
Expected value of objective function, $\cdot 10^5$	-7,5982	-7,7539
Strategy (cash, bonds, stocks) at $t = 0$	(0, 40, 60)	(0, 40, 60)

**Table 6.** The optimal values under different dependency structures with catastrophe event

	Gaussian dependency	Student's $t_2$ -dependency
Stochastic value of objective function, $\cdot 10^5$	-1,7746	-1,7720
Expected value of objective function, $\cdot 10^5$	-0,2228	-0,2199
Strategy (cash, bonds, stocks) at $t = 0$	(0, 40, 60)	(0, 40, 60)

If the copula effect on the portfolio composition is explored, one can see that under Student's  $t_2$  dependency structure the excess over target surplus is larger than the excess obtained under Gaussian dependency structure if the catastrophe event is ignored (Table 5). The conclusion is opposite if catastrophe event is not ignored (Table 6). The optimal strategy vector is (0, 40, 60) in cash, bonds, and stocks for all cases.

**7.4. Stability testing for the stochastic program**

Since the input to the stochastic program the multistage multidimensional scenarios tree involves the randomness, it should be tested for stability (Kaut and Wallace 2007). Let denote the constructed scenarios tree by  $\tilde{\xi} = \left\{ \tilde{\xi}_\tau \right\}_{\tau=1}^{T_\tau}$ . The stability requirement means that if we generate  $G$  scenarios trees  $\tilde{\xi}^g = \left\{ \tilde{\xi}_\tau^g \right\}_{\tau=1}^{T_\tau}$ ,  $g = \overline{1, G}$  and solve the stochastic programming problem with each tree, we should get approximately the same optimal value of the objective function. Since we do not have a representation of the true distribution, we perform the in-sample stability testing.

To test the in-sample stability, 25 five-stage 3-dimensional scenarios tree with branching scheme  $K_\tau = 2$  and  $K_\tau = 3$  were generated. The instance of Gaussian dependency structure between real interest rate and inflation rate, with the catastrophe event not ignored, is explored. The stochastic optimization problem is formulated as in Section 7.3. Sample means and standard deviations of the optimal values of investment problem obtained for different sizes of scenarios set and different branching schemes are given in Table 7.

One can see that the standard deviation is reduced when the number of simulated data paths is enlarged. The optimal solution obtained from the scenario tree with branching scheme  $K_\tau = 3$  has larger standard deviation comparing to the case with branching scheme  $K_\tau = 2$ .

We can not say anything about the “true” optimal solution, because we do not have the “true” probability distribution of stochastic variables.

**Table 7.** In-sample stability test for the instance with Gaussian dependency structure and catastrophe losses

Value of objective function	# of simulated data paths (scenarios)		
	1000	1500	2000
Branching scheme $K_\tau = 2$			
Average, $\cdot 10^5$	-1,3073	-1,3759	-1,3839
Standard deviation, $\cdot 10^5$	0,6365	0,6127	0,6009
Branching scheme $K_\tau = 3$			
Average, $\cdot 10^5$	-1,9517	-1,8258	-1,7324
Standard deviation, $\cdot 10^5$	0,8095	0,7606	0,6128

## 8. Conclusions

In this paper, the composition of investment portfolio in insurance business was considered as the problem of dynamic decision-making under uncertainty. The different asset mixes by different combinations of the weights applied to the investment portfolio were explored, i.e. resources were allocated among a few aggregated asset classes, such as cash, stock and bonds.

The performance of two alternative approaches applied for the decision-making under uncertainty was compared. The results showed that for the considered case the multistage stochastic programming (optimization) dominated the stochastic simulation approach: the excess over the target wealth (which was set approximately equal to the surplus at the end of planning horizon if stochastic simulation was applied) is obtained. Investment strategy obtained from simulation model was different from the strategy generated from stochastic program. It determined that the stochastic parameters of optimization problem had the scenarios tree structure and allowed the possibility to rebalance the decisions in the planning horizon, while the stochastic simulation was applied for the strategy evaluation over scenarios fan and did not allow adapting the strategy. If the simulation approach was applied, the rebalancing strategies were difficult to evaluate because the set of alternatives strategies was enough large and it was very time consuming. It is a drawback of this approach. The multistage stochastic optimization allows to choose optimal decisions, which means that the objective will be achieved in optimally way. But this field is still missing good solvers, and at this moment it is a very intensive research area.

During the investigation of copula effect on the surplus of insurance company, it was concluded that the employed copula function and the probability of catastrophe event had the influence on the size of surplus, but the strategy vector was the same.

## References

- Aas, K. 2004. *Modelling the dependence structure of financial assets: a survey of four copulas*, Research Report, SAMBA/22/04, Norwegian Computing Centre, 1–22. Available from Internet: <<http://www.nr.no/files/samba/bff/SAMBA2204c.pdf>>.
- Beusekom-Bastiaans, I. 2005. Dynamic financial analysis: introduction to nonlife insurance decisions, in *Paper of Business Mathematics and Informatics*, Netherlands, 1–33. Available from Internet: <<http://www.few.vu.nl/stagebureau/werkstuk/werkstukken/werkstuk-beusekom.pdf>>.
- Collomb, A. 2004. *Dynamic asset allocation by stochastic programming methods*. Thesis of Doctor of Philosophy, 1–117. Available from Internet: <<http://www.stanford.edu/group/SOL/dissertations/collombthesis.pdf>>.
- Dempster, M. A. H.; Germano, M.; Medova, E. A.; Villaverde, M. 2003. Global asset liability management, *British Actuarial Journal* 9(1): 137–195.
- Domenica, N.; Birbilis, G.; Mitra, G.; Valente, P. 2007. Stochastic programming and scenario generation within a simulation framework: an information systems perspective, *Decision Support Systems* 42(4): 2197–2218.
- Dupačová, J. 1998. Stochastic programming: approximation via scenarios, *Aportaciones Mathematicas, Ser. Communications* 24: 77–94.
- Dupačová, J.; Consigli, G.; Wallace, S.W. 2000. Scenarios for multistage stochastic programs, *Annals of Operations Research* 100: 25–53.
- Eling, M.; Toplek, D. 2007. *Modeling and Management of Nonlinear Dependencies – Copulas in Dynamic Financial Analysis*. Available from Internet: <<http://ssrn.com/abstract=973758>>.
- Embrechts, P.; McNeil, A.; Straumann, D. 2002. Correlation and Dependency in Risk Management: Properties and Pitfalls, in *Risk Management: Value at Risk and Beyond*, Dempster M. A. H. (Ed.), UK: Cambridge University Press, 176–224.
- Embrechts, P.; Resnick, S.; Samorodnitsky, G. 1999. Extreme value theory as a risk management tool, *North American Actuarial Journal* 3(2): 30–41.
- Gassmann, H. I.; Kristjansson, B. 2007. The SMPS format explained, *IMA Journal of Management Mathematics*, Oxford 1–31.
- Hibbert, J.; Mowbray, P. and Turnbull, C. 2001. A stochastic asset model & calibration for long-term financial planning purpose, *Technical Report*, UK: Barrie&Hibbert Limited, 1–76.
- Kall, P.; Mayer, J. 2007. *SLP–IOR user’s guide: version 2.2.1.*, 1–237. Available from Internet: <[http://www.ior.uzh.ch/Pages/English/Research/StochOpt/SLP\\_Users\\_Guide.pdf](http://www.ior.uzh.ch/Pages/English/Research/StochOpt/SLP_Users_Guide.pdf)>.
- Kaufmann, R.; Gadmer, A.; Klett, R. 2001. Introduction to dynamic financial analysis, *Astin Bulletin* 31: 213–250.
- Kaut, M.; Wallace, S. W. 2007. Evaluation of scenario generation methods for stochastic programming, *Pacific Journal of Optimization* 3(2): 257–271.
- Kaut, M.; Wallace, S. W. 2006. Shape-based scenario generation using copulas, *Stochastic Programming E-Print Series*. 19: 1–17. Available from Internet: <<http://edoc.hu-berlin.de/series/speps/2006-19/PDF/19.pdf>>.
- Kole, E.; Koedijk, K.; Verbeek, M. 2007. Selecting copulas for risk management, *Journal of Banking & Finance*, Elsevier 31(8): 2405–2423, August.
- Kouwenberg, R.; Zenios, S. A. 2006. Stochastic programming models for asset liability management, *Handbook of Asset and Liability Management*, North-Holland, Ch.6, 254–303.
- Landsmana, Z.; Sherrisb, M. 2001. Risk measures and insurance premium principles, *Insurance: Mathematics and Economics* 29(1): 103–115.

- Lowe, S.; Stanard, J. 1997. An integrated dynamic financial analysis and decision support system for a property catastrophe reinsurer, *Astin Bulletin* 27(2): 339–371.
- Mitra, S. 2006. Scenario generation for stochastic programming, *White paper, Optimisk Systems*, UK, 1–34.
- Murty, K. G. 2003. *Optimization models for Decision making*. USA: Self-Teaching Web-book, Ch.1. Available from Internet: <[http://ioe.engin.umich.edu/people/fac/books/murty/opti\\_model/](http://ioe.engin.umich.edu/people/fac/books/murty/opti_model/)>.
- Nelsen, R. 2006. *An Introduction to Copulas*. New York: Springer-Verlag, 1–270.
- Nicholls, B.; Skinner, J. 2007. *Making use of DFA (Dynamic financial analysis)*. Presented to the Institute of Actuaries of Australia. Available from Internet: <[http://www.actuaries.asn.au/IAA/upload/public/7\\_d\\_Conv07\\_Paper\\_Nicholls\\_The%20Reality%20of%20DFA.pdf](http://www.actuaries.asn.au/IAA/upload/public/7_d_Conv07_Paper_Nicholls_The%20Reality%20of%20DFA.pdf)>.
- Nobles, T. 2007. *Dynamic financial analysis results support business decisions*. Report of DWIGHT asset management company. Available from Internet: <[http://www.dwight.com/pubs/dwight\\_DFA\\_model0307.pdf](http://www.dwight.com/pubs/dwight_DFA_model0307.pdf)>.
- Pfeifer, D.; Nešlehová, J. 2003. Modeling dependence in finance and insurance: the copula approach, *Journal Blätter der DGVFM* 26(2): 177–191.
- Pirbhai, M.; Mitra, G.; Kyriakis, T. 2003. *Asset liability management using stochastic programming*, Research paper, Brunel University, 1–15. Available from Internet: <<http://hdl.handle.net/2438/748>>.
- Pranevičius, H.; Sutiene, K. 2007. Copula effect on scenario tree, *IAENG International Journal of Applied Mathematics* 37(2): 112–126.
- Pranevičius, H.; Sutiene, K. 2006. Simulation of dependence between asset returns in insurance, in *Proc. of International Conference on Operational Research: Simulation and Optimisation in Business and Industry*, 23–28.
- Pranevičius, H. 2004. *Kompiuterių tinklų protokolų formalusis specifkavimas ir analizė: agregatinių metodas* [Formal specification and analysis of protocols in computer networks]. Kaunas: Technologija, 1–186.
- Rosenberg, J. V.; Schuermann, T. 2006. A general approach to integrated risk management with skewed, fat-tailed risks, *Journal of Financial Economics* 79(3): 569–614.
- Shiu, Y. M. 2006. Dynamic financial analysis in insurance, 1–60. Available from Internet: <[http://www.actuaries.ca/meetings/stochastic-investment/2006/pdf/2101\\_v.2.doc](http://www.actuaries.ca/meetings/stochastic-investment/2006/pdf/2101_v.2.doc)>.
- Wang, S. 1997. Aggregation of correlated risk portfolios: models and algorithms, Preprint, *Casualty Actuarial Society*, 848–939. Available from Internet: <<http://www.stats.uwo.ca/faculty/ren/as505a/correlated%20portfolio.pdf>>.
- Wirch, J. L. 1999. Raising value at risk, *North American Actuarial Journal* 3(2): 106–115.
- Yu, L. Y.; Ji, X. D.; Wang, S. Y. 2003. Stochastic programming models in financial optimization: survey, *AMO – Advanced Modeling and Optimization* 5(1): 1–26.
- Ziemba, W. T. 2003. *The Stochastic Programming Approach to Asset, Liability, and Wealth Management*. USA: The Research Foundation of the Association for Investment Management and Research, 1–192.

## JUNGINIŲ ĮTAKOS DRAUDIMO KOMPANIJOS INVESTICINIAM PORTFELIUI TYRIMAS

H. Pranevičius, K. Šutienė

Santrauka

Sprendimai, susiję su ilgalaikiu draudimo kompanijos veiklos planavimu, yra dažniausiai veikiami aplinkos neapibrėžtumu, todėl dalis ar visi modelio parametrai nėra iki galo žinomi tuo momentu, kai sprendimai turi būti priimti. Šie parametrai dar vadinami rizikos veiksniais. Kadangi draudimo kompanijos veiklai įtaką daro tam tikra rizikos faktorių aibė, tai formuojama daugiamatė neapibrėžties erdvė su galimomis priklausomybėmis tarp šios erdvės kintamųjų – rizikos veiksmų. Jų priklausomybei modeliuoti taikoma alternatyvi metodika – junginiai: tai funkcijos, leidžiančios aprašyti netiesines priklausomybes tarp stochastinių kintamųjų, nebūtinai pasiskirsčiusių pagal normalųjį dėsnį. Šio darbo tikslas – ištirti junginių įtaką draudimo kompanijos sprendimams, susijusiems su ilgalaikiu investicinės veiklos planavimu. Tokio tipo uždaviniuose egzistuoja gan daug stochastinių parametrų, ir sprendimai turi būti parenkami taip, kad grąža iš investuojamo turto leistų padengti draudimo kompanijos išpareigojimus laikui einant bei uždirbti kuo daugiau pelno. Tikslui pasiekti taikomos dvi skirtingos sprendimų priėmimo modeliavimo metodikos: tai imitacinis modeliavimas ir stochastinis programavimas (optimizavimas). Šios metodikos daugiausia skiriasi tuo, kaip parenkami sprendimai: stochastinis imitavimas remiasi efektyvaus rinkinio koncepcija, o taikant antrąjį metodą sprendimai gaunami iš daugelio tochastinio optimizavimo modelio etapų. Bendra savybė yra ta, kad stochastinis procesas, aprašantis investicinės veiklos rizikos faktorius, yra esminė įvestis į abu modelius ir yra apibrėžiamas sudarant scenarijų aibes. Eksperimento pavyzdyje taikomos dvi funkcijos – Gauso junginys ir Stjudento  $t_2$  junginys – šių rizikos veiksmų priklausomybėms aprašyti generuojant scenarijų aibes.

**Reikšminiai žodžiai:** stochastinis imitavimas, stochastinis optimizavimas, scenarijų generavimas, sprendimų priėmimas, junginių funkcijos, investicinis portfelis, turto ir išpareigojimų valdymas, draudimas.

**Henrikas PRANEVIČIUS.** 1941, Kaunas, Lithuania. Professor, Dr. Habil., Department of Business Informatics at Kaunas University of Technology. Author received his Doctor degree at Kaunas Polytechnic Institute in 1970, Habilitation at Ryga Electronic and Computer Technical Institute in 1984. His research interests include the formal specification, validation and simulation of complex systems, knowledge-based simulation, and development of numerical models of systems specified by Markov processes. The results of investigations have been successfully applied in creating the computerized systems for specification, validation and simulation/modelling of computer network protocols, logistics and industrial systems. The theoretical background of investigation is Piece-Linear Aggregate formalism, which permits to use the formal specification for model development and behaviour analysis. His e-mail address is: [hepran@vik.ktu.lt](mailto:hepran@vik.ktu.lt).

**Kristina ŠUTIENĖ.** 1979, Kaunas, Lithuania. PhD student in Business Informatics Department at Kaunas University of Technology. The title of her thesis “The modelling of underwriting and investment activities for decision-making”. Student’s research interests include statistical forecasting, stochastic simulation and optimization, operational research applied to business processes. Her e-mail address is: [kristina.sutiene@ktu.lt](mailto:kristina.sutiene@ktu.lt).